

# A Guide to the TracPhone F55 & F77 user's guide



**KVH TracPhone® F55 & F77**

# Congratulations!

You have selected one of the most advanced and convenient marine communications systems available today. The KVH® Industries' TracPhone® F33/F55/F77 system, manufactured by Thrane & Thrane, is designed to provide high-quality voice, fax, data, and high-speed Internet access.

## Technical Support

Please direct any technical questions to:

### North America

KVH Industries, Inc.  
50 Enterprise Center  
Middletown, RI 02842 USA  
Tel: +1 401 847-3327  
Fax: +1 401 849-0045  
E-mail: techs@kvh.com  
Internet: www.kvh.com

### Europe/Middle East/Africa

KVH Europe A/S  
Kokkedal Industripark 2B  
2980 Kokkedal, Denmark  
Tel: +45 45 160 180  
Fax: +45 45 160 181  
E-mail: customersupport@kvh.dk  
Internet: www.kvh.com

## Product Registration

Don't forget to register your TracPhone system for KVH's **free** customer support subscription service. When you register, you will receive technical and service updates specific to your system along with customer support and product news. In addition, with your information on file, KVH will be able to offer you even faster, more convenient product, customer, and warranty support. *KVH will NOT sell or share your data with other companies or organizations.*

To register your system, simply fill out the enclosed Product Registration Form or visit [www.kvh.com/register](http://www.kvh.com/register).



## Product Information

Before installing the TracPhone, be sure to write down the following information:

ISN: \_\_\_\_\_

Above Decks Unit (ADU)

S/N: \_\_\_\_\_

Below Decks Unit (BDU)

S/N: \_\_\_\_\_

BDU Build Date: \_\_\_\_ / \_\_\_\_ / \_\_\_\_  
                          YY  MM  DD

**This information will be required for all troubleshooting or service calls made regarding this product.**



## PLEASE READ!

### Important Notice About Your Data Connection

To prevent inadvertent airtime usage, the user must disconnect the data connection when not in use. If the data connection is not properly disconnected, your computer may dial out on its own, which could result in an unintended airtime charge.

KVH accepts no responsibility if this occurs. It is the vessel owner's responsibility to ensure that the TracPhone is correctly interfaced with the vessel's computer.

If you have any questions about data connections, please contact KVH Technical Support.

# Thrane & Thrane A/S

SAILOR Fleet77 TT-3084A

SAILOR Fleet55 TT-3086A

User Manual

**Document number:** TT98-116874-H

**Release date:** March 14, 2007

Information in this document is subject to change without notice and does not represent a commitment on the part of Thrane & Thrane A/S. It is recommended that the latest version of the manual is downloaded from the Thrane & Thrane extranet or requested from the distributor.

## Copyright

© 2007 Thrane & Thrane A/S. All rights reserved. Printed in Denmark.

## Trademark Acknowledgements

- **Inmarsat** is a registered trademark of the International Maritime Satellite Organisation (IMSO) and is licensed by IMSO to Inmarsat Limited and Inmarsat Ventures plc.
- **Inmarsat's product names** are either trademarks or registered trademarks of Inmarsat.
- **WinPoET** is a trademark of iVasion, a RouterWare Company.
- Other product and company names mentioned in this manual may be trademarks or trade names of their respective owners.

### Company Addresses

[www.thrane.com](http://www.thrane.com)

#### Denmark

**Thrane & Thrane A/S**  
Lundtoftegårdsvej 93 D  
DK-2800 Kgs. Lyngby  
Denmark

T: +45 39 55 88 00  
F: +45 39 55 88 88

#### Denmark

**Thrane & Thrane Aalborg A/S**  
Porsvej 2  
DK-9200 Aalborg SV  
Denmark

T: +45 39 55 88 00  
F: +45 96 34 61 01

#### USA

**Thrane & Thrane, Inc.**  
509 Viking Drive, Suites K, L and M  
Virginia Beach, VA 23452  
USA

T: +1 (757) 747-2341  
F: +1 (757) 463-9581

#### China

**Thrane & Thrane Shanghai  
Representative Office**  
28J Pufa Tower  
588 Pudong Rd(S), Pu Dong  
200120 Shanghai  
P. R. China

T: +86 21 68 87 87 80  
F: +86 21 68 87 71 12

## Safety Summary

The following general safety precautions must be observed during all phases of operation, service and repair of this equipment. Failure to comply with these precautions or with specific warnings elsewhere in this manual violates safety standards of design, manufacture and intended use of the equipment. Thrane & Thrane A/S assume no liability for the customer's failure to comply with these requirements.

### Microwave Radiation Hazards

During transmission the antenna in this system radiates Microwave Power. This radiation may be hazardous if exposed directly to humans, close to the antenna. During transmission, make sure that nobody gets closer than the recommended minimum safety distance. The minimum safety distance to the antenna on the focal line, is 3.6m.

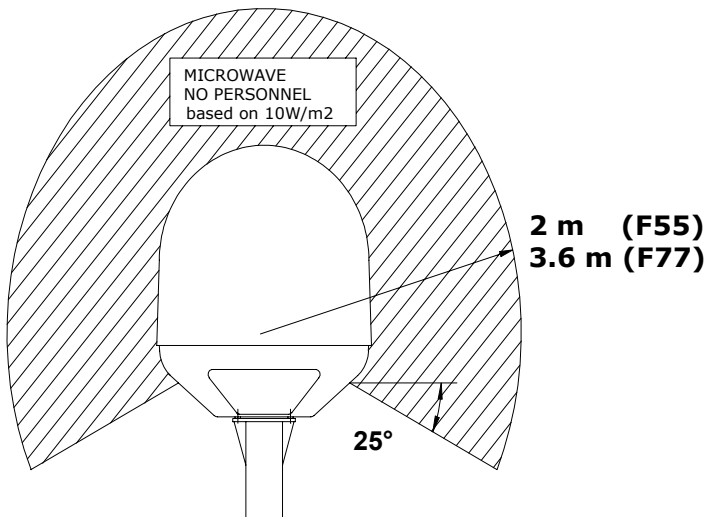

### GROUND THE EQUIPMENT

To minimize shock hazard, the equipment chassis and cabinet must be connected to an electrical ground.

**DO NOT OPERATE IN AN EXPLOSIVE ATMOSPHERE**

Do not operate the equipment in the presence of flammable gases or fumes. Operation of any electrical equipment in such an environment constitutes a definite safety hazard.

**KEEP AWAY FROM LIVE CIRCUITS**

Operating personnel must not remove equipment covers. Component replacement and internal adjustment must be made by qualified maintenance personnel. Do not replace components with the power cable connected. Under certain conditions, dangerous voltages may exist even with the power cable removed. To avoid injuries, always disconnect power and discharge circuits before touching them.

**DO NOT SERVICE OR ADJUST ALONE**

Do not attempt internal service or adjustments unless another person, capable of rendering first aid resuscitation, is present.







# Table of Contents

---

<b>Chapter 1</b>	<b>About the Manual</b>	
<b>Chapter 2</b>	<b>Introduction</b>	
	The Inmarsat Fleet Service .....	3
	The SAILOR Fleet77 system .....	7
	The SAILOR Fleet55 system .....	10
	Hardware Interfaces .....	13
	The Handset .....	22
	Distress Cradle .....	33
<b>Chapter 3</b>	<b>Getting started</b>	
	Getting ready to make a call .....	35
	Use of PIN codes. ....	39
	Normal calls .....	41
	Distress call .....	43
	MPDS connection .....	45
	ISDN Connection .....	47
<b>Chapter 4</b>	<b>Operation</b>	
	Menu System .....	49
	Call functions .....	60
	Super User functions .....	64
<b>Chapter 5</b>	<b>PC programs</b>	
	System set-up using FleetCP .....	93

	Setting up data equipment .....	104
	Setup using Ethernet/PPPoE.....	128
<b>Chapter 6</b>	<b>Troubleshooting</b>	
	List of Error messages.....	133
<b>Appendix A</b>	<b>Menu Tree</b>	
<b>Glossary</b>	.....	163
<b>Index</b>	.....	167

## *About the Manual*

Congratulations on purchasing your SAILOR Fleet product.

Whether you have chosen a TT-3084A SAILOR Fleet77 or a TT-3086A SAILOR Fleet55, the system makes it possible for you to communicate from virtually any ocean region in the world using the Inmarsat Fleet service established by Inmarsat.

Both systems support high-speed data (64 kbps circuit switched and packet data) and high quality voice as well as inexpensive voice services. In addition the SAILOR Fleet77 optionally supports 128 kbps data service.

This manual has the following chapters:

- **Introduction** - an overview of the Inmarsat Fleet system and its services.
- **Getting started** - a description of how to make and receive calls and the use of PIN codes.
- **Operation** - a detailed description of the menu system in the terminal.
- **PC programs** - a description of how to use the accompanying configuration PC software (FleetCP) and to setup the PC for data connections.
- **Troubleshooting** - a description of the most common errors, how to deal with them and how to get further help if necessary.

Additionally you will find a glossary of abbreviations and an index at the end of the manual.



# Introduction

## The Inmarsat Fleet Service

### Overview

The Inmarsat Fleet service is based on 4 Geostationary 3rd generation satellites situated above the equator, but can also operate on the new 4th generation satellites. Geostationary means that the satellites are always located in the same position, i.e. they rotate at the same speed as that of the earth. Each satellite covers a certain area (footprint) and supports a number of powerful spot-beams making the service available in virtually all ocean regions on the earth between approximately 70°N and 70°S.

#### The 4 Geostationary Inmarsat Satellites

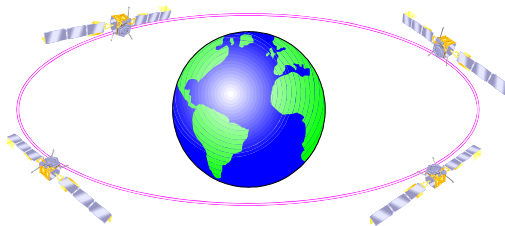

The satellites are your connection to the worldwide networks, and they are managed by the Network Coordination Stations (NCSs), run by Inmarsat. The primary functions of the NCSs are to constantly keep track of which terminals are logged on to the system, and assign a free channel whenever a call is made.

The gateway between the public network and the satellites is operated by Land Earth Stations (LES). The LESs are run by different operators around the world.

## Services

The Inmarsat Fleet service supports the following services:

- **High speed services**
  - 2 x 64 / 2 x 56 kbps data<sup>1</sup>
  - 64 kbps data
  - 56 kbps data
  - Speech
  - 3.1 kHz audio
  - MPDS
- **Low speed services**
  - Mini-M voice
  - 9.6 kbit fax

For a detailed description of each service see the last section of this chapter.

---

1. 128 kbps is only available on new F77 systems

The above-mentioned services allow for a wide range of applications. Examples are shown below.



### Important

Before a terminal can be used on the network, it has to be commissioned by one of the Inmarsat Service Providers (ISPs). In order to use the different Inmarsat Fleet services it is necessary to have at least one Inmarsat Mobile Number (IMN) for each of the above mentioned services. In case all 8 services are commissioned on your terminal, you will have 8 IMN numbers.

Calling an Inmarsat Fleet terminal corresponds to making international calls. If the satellite region/area is not known for the terminal the “country” code for a terminal is 870. When you dial up to an Inmarsat Fleet terminal through the public network, you have to dial the IMN number in addition to the international access code for Inmarsat, e.g.:

**+870 600 555 555**

Making calls from an Inmarsat Fleet terminal corresponds to making international calls, meaning you must always dial the country code.



## Service explanation

The low speed services have a lower tariff than the high speed services, because the high speed services are high quality audio or high speed data services that require more bandwidth.

- The **128 kbps UDI** (Unrestricted Digital Information) service enables 2 x 64 kbps or 2 x 56 kbps bidirectional transmission of data to and from terrestrial **ISDN** networks
- The **64 kbps UDI** (Unrestricted Digital Information) service enables the bidirectional transmission of data to and from terrestrial 64 kbps **ISDN** networks. The **56 kbps UDI** service is similarly used to make a connection to 56 kbps ISDN networks, which are primarily used in North America.
- The **Speech** and **3.1 kHz audio** services make it possible to establish high quality analogue connections of a quality equal to terrestrial analogue connections via digital networks/switches. The **Speech** service is used for high quality voice connections, whereas **3.1 kHz audio** can be used to transfer analogue signals between fax machines and modems with an analogue 2-wire interface. The 3.1 kHz audio service is transparent, and is suitable for all analogue applications including secure telephones.
- The **MPDS service** is a packet data service where the tariff depends on the amount of data sent and received. This service is a more cost-effective solution for web browsing, and other applications where there is no need for constant transmission of data in both directions. It is also suitable for applications where a constant connection is required, because the user is no longer charged the “per minute rate”.
- The **Mini-M voice** service is only for voice transmission. The voice transmitted over the satellite is subject to a compression process that reduces the bandwidth to 4.8 kbps and consequently reduces the cost.
- The **9.6 kbit Fax** allows you to send and receive fax messages using a standard office fax machine. This service replaces the previous Mini-M fax service. Using this service is usually more cost effective compared to the 3.1 kHz audio service.

## The SAILOR Fleet77 system

### Overview

The SAILOR Fleet77 System includes the following system components:

- TT-3008C SAILOR Fleet77 Antenna (ADU)
- TT-3038C SAILOR Fleet77 Electronics Unit (BDU)
- TT-3622B SAILOR Fleet77 Distress Cradle
- TT-3620F SAILOR Fleet Control Handset (4 wire)
- Accessories (manual, software, etc.)



For instructions on how to assemble the system, wiring and specifications, see the Installation Manual.

## TT-3008C Antenna



The TT-3008C antenna or ADU (Above Deck Unit) is a stabilized high-gain antenna. The antenna contains all functions for satellite tracking including a GPS system.

## TT-3038C-128 SAILOR Fleet77 Electronics Unit (BDU)



All connectors for external equipment are placed on the rear of the terminal (BDU-Below Deck Unit). On the front a configuration module is attached. This module stores all system configuration data. It contains all necessary data to recover the system after a replacement of the BDU.

## TT-3622B SAILOR Fleet Cradle with Distress and TT-3620F SAILOR Fleet Control Handset (4 wire)

The handset is primary used to make telephone calls. Furthermore it can be used to configure the system. For a detailed description of the handset see the section *The Handset* on page 22.



The cradle has a distress button, a stop button and three LEDs. The distress button, which is protected by plastic glass, is used to initiate a distress call. The stop button can be used to abort a distress call. The three LEDs indicate power, distress test and priority calls. For a detailed description of the cradle see the section *Distress Cradle* on page 33.

## The SAILOR Fleet55 system

### Overview

The SAILOR Fleet55 System includes the following system components:

- TT-3008F SAILOR Fleet55 Antenna (ADU)
- TT-3038C-WMx SAILOR Fleet55 Electronics Unit (BDU)
- TT-3622C SAILOR Fleet Cradle without Distress
- TT-3620F SAILOR Fleet Control Handset (4 wire)
- Accessories (manual, software, etc.)



For instructions on how to assemble the system, wiring and specifications, see the Installation Manual.

## TT-3008F SAILOR Fleet55 Antenna



The TT-3008F antenna or ADU (Above Deck Unit) is a stabilized high-gain antenna. The antenna contains all functions for satellite tracking including a GPS system.

## TT-3038C-WMx SAILOR Fleet55/77 Electronics Unit (BDU)



All connectors for external equipment are placed on the rear of the terminal (BDU-Below Deck Unit). On the front a configuration module is attached. This module stores all system configuration data. It contains all necessary data to recover the system after a replacement of the BDU.

## TT-3622C SAILOR Fleet Cradle without Distress and TT-3620F SAILOR Fleet Control Handset (4 wire)



The handset is primarily used to make telephone calls. Furthermore it can be used to configure the system. For a detailed description of the handset see section *The Handset* on page 22.

# Hardware Interfaces

## Overview

The Electronic Units of the SAILOR Fleet77 and the SAILOR Fleet55 have the following hardware interfaces:

- Analogue RJ11 number 1 **(X1)**
- Analogue RJ11 number 2 **(X2)**
- Analogue RJ11 number 3 **(X3)**
- Handset 1 **(X4)**
- Handset 2 **(X5)** (For future use)
- ISDN (Integrated **S**ervices **D**igital **N**etwork) **(X7)**
- USB (**U**niversal **S**erial **B**us) **(X8)**
- Ethernet **(X9)**
- Serial connector 1 **(X10)**
- NMEA 0183/2000 **(X11)**
- 4 Discrete I/O **(X12)**
- Power Connector **(X13)**

All connectors for these interfaces are found on the rear of the Electronic Unit:



These interfaces can be used for the different Inmarsat Fleet services.



## Two Cradle/Handset interfaces



The BDU has two 4 wire handset ports with RS-485 data control.

Each handset can be used to set up the terminal and it can be used to make or receive phone calls using one of the following services:

- Speech
- 3.1 kHz audio
- Mini-M voice
- Distress call

## Three Analogue RJ11 interfaces



The RJ11 ports shown above can be used for connection of analogue phones. For all interfaces the following services can be used:

- Speech
- 3.1 kHz audio
- Mini-M voice
- 9.6 kbps fax

The type of service used on each interface is independent of each other and can be configured in the Routing menu.

## ISDN interface



This interface can be used for connection of ISDN equipment – data as well as voice/picture based equipment (phones, modems, terminal adapters, audio codecs, video conferencing equipment, STE secure voice, etc.).

On F55 only one B-channel (1 x 64 kbps Data) and one D-channel (control) is used.

The F77 optionally supports two B-channels (2 x 64 kbps Data). In order to enable this service you need to enter a special PIN code. Please contact your supplier to retrieve a pin code. As with other services the terminal needs to be commissioned to this service (see the section *The Inmarsat Fleet Service* on page 3).

The terminal does not support dynamic switching between one and two B-channels. The user needs to decide to use one or two channels before establishing the call.

When using only one B-channel, please ensure that your ISDN equipment is configured to support one B-channel only.

The following services may be used on the ISDN interface:

- 128 kbps UDI (option on F77)
- 64 kbps UDI
- 56 kbps UDI
- Speech
- 3.1 kHz audio
- Mini-M voice

Like the terrestrial ISDN network the terminal offers the possibility to have more than one device connected to this interface. Each device can be

individually addressed when called, and the service type can be selected individually. This requires that the attached equipment supports MSN (Multiple Subscriber Number). Depending on the brand of equipment it may be possible to program the equipment with more MSNs. If a device should respond to a certain IMN number, it must be programmed in the ISDN equipment using the IMN as MSN. Note that the equipment will only react if both MSN and service type (speech, 3.1 kHz audio, 128 kbps, 64 kbps or 56 kbps) fit the ISDN equipment.

**Note**

When the 128 kbps service is not used, the ISDN interface supports data transmission of one B-channel at 64 or 56 kbps as opposed to two B-channels at 64 or 56 kbps available on the terrestrial ISDN network.

When using satellite equipment a delay is introduced due to the satellite link. Not all standard ISDN devices are equally good at coping with this.

## RS-232 interface



The RS-232 interface is a standard 9-pin serial ports, with a maximum port speed of 115.2 kbps. The interface supports the following service types:

- MPDS service
- Configuration of the terminal via FleetCP software (See the section *System set-up using FleetCP* on page 93)
- Connection of an IP Router
- 64 kbps UDI using RS-232

When using the FleetCP program, the PC must be connected to the RS-232 interface.

## NMEA 0183/2000 interface



The NMEA 0183/2000 is a Gyro and Navigation interface. It serves as a backup, if an alternative antenna with no self-steering function has to be installed.

**Note** | The NMEA 0183/2000 interface is currently not supported.

## Discrete I/O interface



The transceiver also has a discrete I/O interface, containing 4 configurable input/output.

Each input/output pin can be configured to one of these functions:

As input types: TxOffIn, RSOffIn

As output types: TxOffOut, RSOffOut, TxActiveOut

TxOffIn:	Input activates TxOff functionality.
RSOffIn:	Input activates Radio Silence functionality.
TxOffOut:	Output indicates that TxOff is active.
RSOffOut:	Output indicates that Radio Silence is active.
TxActiveOut:	Output indicates that Transmit is active.

Each input or output pin can be configured as either active high or low.

**TxOff (Transmit Off):**

When this function is active the terminal will stop all transmission from the antenna by terminating the call as it is normally done. Distress alarms from ship or from land will be allowed.

**RS (Radio Silence):**

This function has higher priority than the Transmit-Off function. If this function is active any transmission from the antenna will be blocked. Even distress calls in both directions will be prohibited.

Both functions can only be activated by the discrete I/O pins. The pins have to be configured from the Super User menu, which can only be accessed by entering a password.

## USB Interface

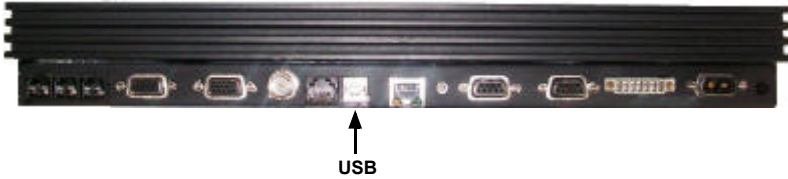

USB - Universal Serial Bus – is an interface that allows a single universal plug to connect PCs. USB replaces the different serial and parallel PC connections with one standard plug-and-play port. Please note that the USB interface only supports the 64 kbps UDI service at present time.

## Ethernet Interface



The Ethernet interface is a RJ45 connector. It can be used for the MPDS service. Connect a computer through a switch or hub or connect directly using a crossover cable.





# The Handset

## Overview

The handset is the primary interface for the SAILOR Fleet system. It enables the user to dial numbers, it displays error and status messages, and it can be used to configure the transceiver.

The handset is divided into 3 distinct and inter-working sections.

1. The first is the Liquid Crystal Display (LCD) and Light Emitting Diodes (LED) section. This section gives the user visual indications about the operation and status of the system.
2. The second is the Function keys section. This section enables the user to interact with the software menu system of the transceiver.
3. The third is the Alpha-Numeric section. This section enables the user to dial and perform data entry functions into the transceiver.

In the following these sections will be described in details.

## LCD/LEDs

### LCD

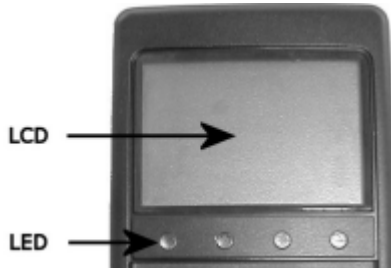

As shown in the picture above, the top of the handset contains the LCD for displaying information to the user. It can be adjusted for contrast and is backlit for viewing in dim light or at night.



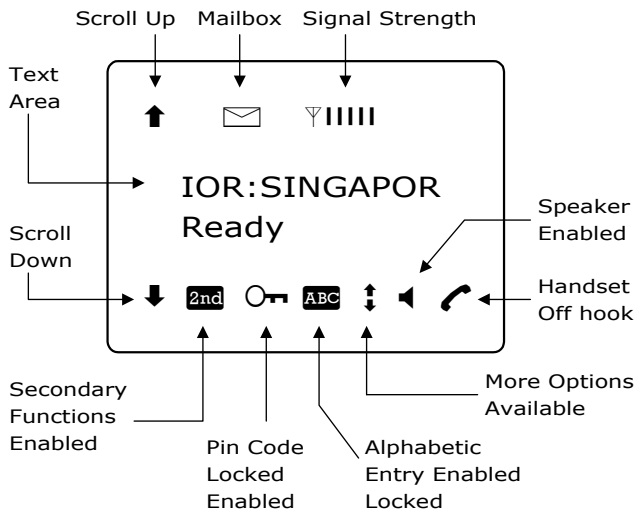











The LCD display is graphically shown below:



The display contains a set of symbols which together with the 4 indicators below the display gives continuous indication of current status.

### Display symbols

The table below explains the meaning of the symbols appearing in the display.

Symbol	Meaning
	More menu entries above.
	More menu entries below.
	Turned on when the  key has been pressed.
	Turned on when the keypad is in alpha mode. Alpha mode is used to enter letters (for example names in the phone book).
	The value in a menu must be selected between certain predefined values by means of the  and  keys.
	The speaker. The user can turn the external speaker on and off by pressing   . The  symbol is displayed in the LCD when the speaker is on.
	Short message stored at a LES – see the sections <i>Mailbox</i> on page 54 and page 82 for further information.
	The number of bars (I) following this antenna symbol indicates received signal strength. Up to 5 bars may be displayed. The number of displayed bars may vary during a call. This is due to a power reduction, negotiated between the terminal and the LES.
	The handset is off hook.

## LEDs

There are four LEDs below the LCD display (see below). From left to right they are Power (GREEN) - Alarm (RED) - Call (AMBER) - Link (GREEN).

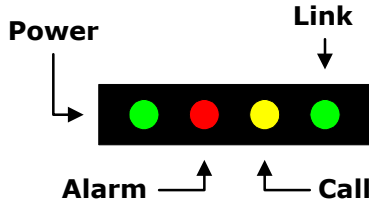

**POWER LED (GREEN):** The Power LED indicates that the system has power.

**ALARM LED (RED):** The Alarm LED indicates that the system has detected a fault. If the LED is lit the error can be examined in the Alarm log. See the section *Alarm Log* on page 55.

**CALL LED (AMBER):** The Call LED flashes when a call is ringing at the receiving end and lights constantly when a connection is made.

**LINK LED (GREEN):** The Link LED indicates that the system is receiving from a satellite. Note that the LED may not light constantly, because the satellite may not be transmitting constantly during a call.

## Function keys

### *Introduction*













The Function keys, as shown above, enable the user to enter the menu system of the transceiver and change various settings.

Each key is described in detail in the next section.

## Key description

Each key is described in detail below.



















Symbol	Meaning
	<p>Menu key: Enters the top level of the menu system. See the section <i>Menu System</i> on page 49.</p> <p>The key can also be used to switch the terminal on and off.</p> <p>To switch on the terminal press the key shortly.</p> <p>To switch off the terminal press the key for a while and check that the LCD display counts down to zero before releasing the key.</p>
	<p>EXIT key: Similar in function to the Esc-key on a PC. While in the menu system, pressing Exit will bring the user back one level until the menu is completely exited. When asked YES or NO by the system, pressing Exit will be interpreted as a NO response. When entering data into the transceiver, pressing exit will cancel the entry.</p>
	<p>OK key: The opposite of the Exit key. It is similar in function to the Enter key on a PC. When in the main screen display, pressing OK will enter the menu system. While in the menus, pressing OK will enter the selected menu. When entering data, such as phone numbers or PIN codes, pressing OK will accept the entry.</p>
	<p>Clear key: This is a dual function key. The primary function is to clear the last entered digit. It is similar in function to the backspace key on a PC.</p> <p>Secondary function: INSERT. This function is accessed by first pressing and releasing the  key and then pressing .</p> <p>The insert function is used to insert new Inmarsat Mobile Numbers (IMNs) into the terminal, insert Phone book entries, etc.</p>

Symbol	Meaning
	<p>SCROLL UP key: Also a dual function key. The primary function is to enable the user to scroll up to menu items not shown on the 2-line display of the LCD.</p> <p>Secondary function: Edit. Allows users to edit previously entered information in the transceiver.</p>
	<p>ABC key: Toggles between normal mode and alpha numeric mode.</p> <p>Secondary function: Delete. Allows users to delete previously entered information.</p> <p>When browsing in the menu system this key can also be used to toggle the short codes on/off. This feature also includes toggling displaying of the short codes on/off. These codes can be used as shortcut to a given menu item by pressing the short code number using the numeric keys.</p>
	<p>2nd key: The 2<sup>nd</sup> function will be applied to the next key. See below.</p>
	<p>SCROLL DOWN key: Is used to scroll down to menu items not shown on the 2-line display of the LCD.</p>
	<p>Toggles between on hook and off hook.</p>











## Second functions

A number of keys have a 2<sup>nd</sup> function.

The following table gives a total overview of the 2<sup>nd</sup> functions.

Symbol	Meaning
 	Recalls the last dialed number.
 	Not used
 	Shortcut to the Area selection submenu, see <i>Area</i> on page 52.
 	Not used.
 	Not used.
 	Not used.
 	Not used.
 	Turn speaker in the cradle on/off.
 	Shows C/No “signal strength” in the display. Pressing  returns to the previous state.



Symbol	Meaning
 	Sets the brightness of the LEDs. See <i>LED Dimm</i> on page 76.
 	Shortcut to the Help desk menu. See <i>Help Desk</i> on page 55.
 	Insert an entry (for example in phone book)
 	Edit an existing entry (for example in phone book)
 	Delete an existing entry (for example in phone book)

## Alpha-Numeric keys

### Introduction



The keypad can be in normal (numeric) mode or alpha mode. Normal mode is used to enter digits (phone numbers) whereas alpha mode is used to enter letters (names in the phone book). The key is used to switch between the two modes and the display indicates if the keypad is in alpha mode.

### Entering letters

In alpha mode each of the numeric keys (plus ) can be used to select between subsets of the alphabet (and certain special characters) by pressing the key a number of times until the wanted letter/character is shown on the display.

**Example:** To insert the letter C, press 3 times in alpha mode.











### Using menu short codes

When browsing in the menus can be used to toggle short codes on/off. These codes can be used as shortcut to a given menu item by pressing the short code number using the numeric keys.

The next section shows the relevant keys in alpha mode.

**Available functions in alpha mode**

The table below shows the available key functions in alpha mode.

Key	Available characters or functions in alpha mode
	- ? ! , . : ' \$ ( ) + / 1
	A B C 2
	D E F 3
	G H I 4
	J K L 5
	M N O 6
	P Q R S 7
	T U V 8
	W X Y Z 9
	Move cursor (forced)
	<space>

# Distress Cradle

## Introduction



### Note

The Distress cradle is only available with the TT-3084A SAILOR Fleet77 system.

Besides being the base for the handset, the Distress cradle is also where a Distress call is initiated or ended.

A speaker for hand free operation is located in the lower left side of the cradle.

Press **2nd** **8** on the handset to toggle the speaker on/off.

## Cradle LEDs and buttons

The cradle includes 3 LEDs and two buttons.



**Distress** button: The Distress button, which is protected by plastic glass, is used to initiate a Distress call. See *To make a Distress call.* on page 43.

**Distress Stop** button: Is used to abort a distress call before the connection is established.

**Power On** LED: Indicates that the system is powered on.

**Priority Call** LED: Indicates a priority call in progress (distress, safety or urgency). See *Priority calls* on page 62.

**Distress Test** LED: Indicates that a distress test is performed. See *DistressTest* on page 79.

## Getting started

### Getting ready to make a call

#### To power on the system.

The system can be powered on from the BDU or from the handset.

#### *Power on from handset*

The handset power button is placed in the upper left corner of the handset keypad (Menu key). See the figure below. To power on the system just press the Menu key.



### ***Power on from BDU***

The BDU power button is placed on the back panel of the BDU. See figure below.



Press and hold the power button for a few seconds or until the green LED on the front of the terminal lights up.



The display and all LEDs on the handset and the cradle will light up for a few seconds.

Below is an example of the normal readout of the handset display, while the BDU is booting.

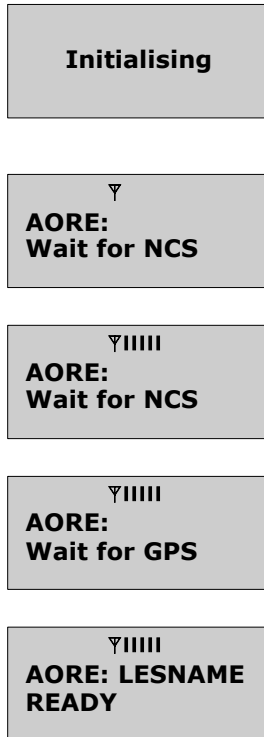

The system may stay in the “Wait for GPS” state for an extended period, if e.g. the antenna has been turned off for a long time or there is not a free view to the GPS satellites. It may take several minutes to obtain the GPS position.

When the display reads “READY” as shown above, the system is ready to make and receive calls.



## To power off the system.

The system can be powered off from the BDU or from the handset.

### *Power off from handset*

The handset power button is placed in the upper left corner of the handset keypad (Menu key).

To power off the system just press and hold the key. After a few seconds the LCD display starts a count down to zero. When the countdown is finished the display shows the message “Release Power Button”. Release the key and the system will power off.

### *Power off from BDU*

Press and hold the power button for a few seconds, until the handset display shows the message shown below.



Release the button and the terminal will shut down.

**Note**

Wait at least 5 seconds after a power down, before trying to power up the system again.

## Use of PIN codes.

### Overview

Access to some of the functions is restricted by a PIN code. Two different kinds of User PIN codes are used in the system: One PIN for the **Super User** and one for the **Service User**.

Common for both PIN types is that the length must be between 4 and 8 digits and that they contain digits between 0 and 9.

The normal everyday user (**Normal User**) can make and receive calls, access the phone book, choose an ocean region and a default LES, read the alarm log and status and make a call from the Helpdesk. For a description of these functions see *Menu System* on page 49. All other setup changes have to be carried out by a Super User or a Service User.

## Super User PIN

The Super User has the same rights as the Normal User. In addition the Super User can access the Super User menu. See *Super User functions* on page 64 for details.

A Super User will typically be a person responsible for setting up and maintaining the system. It is only possible to have one Super User PIN code.

If the PIN is entered incorrectly 3 times, the PIN is blocked. A blocked Super User PIN can only be unblocked by a PUK code or the Service User. The factory PIN code is '12345678'.

## Service User PIN

The Service User has access to all Fleet system functionality that is accessible through the handset.

Only T&T and/or the supplier of the equipment normally know this PIN.

If the PIN is entered incorrectly 3 times, the PIN is blocked. Only a PUK code can unblock a blocked Service User PIN.

For use of the service menu, please refer to the "TT-3084A SAILOR Fleet77, TT-3086A SAILOR Fleet55, Installation Manual".

## STU PIN and 128K PIN

Pin codes must be retrieved from your distributor in order to enable the STU functionality (Secure Telephone Unit) or the 128 kbps service. Please refer to *Additional Features* on page 87 and *Pin codes* on page 95 to see how to enable the service.

## Normal calls



### Call from handset

Any call made from the system uses a service type (Mini-M voice, Speech or 3.1 kHz audio).

The service type used for a call from the handset is the service type configured as default for this handset and the LES operator used will be the default LES operator.

When making calls from the handset, just type in the phone number as if you were making an international call (with prefix for automatic international calls equal to 00).

For example, to dial the number of Thrane & Thrane (+45 39558800), press the number:

00 for international calls, 45 for country code then 39558800, followed by  or . The display on the terminal handset will show how the call proceeds.

Hang up by pressing . During and after a call, the display will show how long the call lasted.

The Phone Book can also be used to initiate a call, either by selecting an entry in the phone book or by using the short code. See *Call using phone book* on page 60 for details.

## Calling the terminal

Calling the terminal or a device connected to the terminal is similar to making international calls. The specific IMN-number<sup>1</sup> has to be preceded by one of the five possible international access codes. This depends on whether you know which area the terminal is within or not:

870: Area of terminal not known

(Requires that the LES supports Mobility Management).

871: AORE

872: POR

873: IOR

874: AORW

To call the IMN-number on a terminal situated in IOR, dial 00873 followed by the IMN number

- 
1. A terminal may have more IMN numbers, because different services exist and more devices may be connected to the different hardware interfaces of the terminal.

# Distress call

## Introduction

### Note

The distress functionality is available on Fleet77 systems only.

A distress call is an automated way of calling for help (SOS). A distress call from the Fleet77 system is a voice call, which means that the call will be connected to an operator at the RCC (Rescue Coordination Center). When the distress call is connected, the ship's position and the MES ID are sent to the RCC. This enables the center to identify and locate the ship.

## To make a Distress call.

To initiate a Distress call, do as follows:



1. Press and hold the **Distress** button on the cradle.



The button will flash with intervals of 1 second and the cradle buzzer will beep with the same interval. After 5 seconds, the button light becomes constant and the buzzer stops beeping. Any ongoing call is preempted, unless it is a Distress call. During the preemption the handset display shows the message 'DISTRESS Wait'.

If the distress button is released within the 5 seconds, the distress call is canceled and the terminal returns to its normal state.

2. Release the Distress button when the light in the button becomes constant.

After the preemption, if any, the handset shows the message 'Select LES'.

Scroll through the LES list with the  and  keys and select the LES by pressing .

If you do not select a LES nor press  or  within 15 seconds, the call will be initiated through the LES pre-configured in the Distress LES. If no Distress LES is configured, the Default LES will be used instead. If no Default LES is configured, the NCS redirects the call to an appropriate LES.

**Note**

If a Distress LES is not defined for each Ocean Region, an alarm will appear and the entry 'Distress LES is not selected in all Ocean Regions' will be added to the alarm log.

**To cancel** the Distress mode, press and hold the **Distress Stop** button, after the button light becomes constant, but before the 15 seconds timer runs out. The display will then show `Distress Aborted`.

**If the Distress call is continued**, the handset will display `DISTRESS - Calling`. The call will be connected to the RCC, the handset will display `DISTRESS - Connected` and the cradle LED 'Priority call' will light up. You can now make the Distress call

3. Use the handset to talk to the RCC operator.

The 'Distress' button light will stay on until the call is aborted.

## Distress call failure.

If the Distress call fails to connect due to a system malfunction (BDU, ADU, satellite or terrestrial), the light in the cradle 'Distress' button will turn off and the system will return to a normal state.

## Distress and Priority call to the ship

The RCC operator can generate a distress alert priority call to the ship. The 'Priority Call' LED will start flashing on all cradles, and if the call has distress priority the buzzer will beep with 1 second intervals. Any calls with lower priority, including MPDS sessions, are preempted and a busy tone is heard.

Answer the distress and priority call by picking up a handset or by pressing



after which the 'Priority Call' LED will light steadily and the buzzer stops beeping.

The 'Priority Call' LED is turned off when the call is terminated.

If the call is not answered by the ship, but terminated by the RCC, the Alarm LED turns on to indicate that there was an unanswered distress alert or priority call. Details about the alarm can be checked in the alarm log.

# MPDS connection

## Introduction

**Note**

The MPDS service is only available on Fleet55 systems when the vessel is positioned inside an area with Spot Beam coverage. On Fleet77 systems the service is also available in global beam.

Mobile Packet Data Service (MPDS) is a service that allows the mobile user to remain “always connected” to the Internet with billing based on the amount of data transferred rather than the time spent online. This makes the service an ideal and cost effective solution for applications like Web browsing, email services, IP/LAN connectivity and small to medium size file transfer. The MPDS service provides a 64 kbps shared channel.

While in MPDS mode the TT-3084A is flagged busy in the Inmarsat network. This means that the Fleet system is not able to receive any incoming calls until it returns to normal idle mode. However, the user can enable the Call Waiting Notification feature. This allows the system to receive voice calls during an ongoing MPDS call. For further information about this feature, see *Call waiting* on page 45.

The sections *Setting up MPDS over RS-232* on page 104 and *Setup using Ethernet/PPPoE* on page 128 contain descriptions of how to setup an MPDS connection using your PC.







## Call waiting

As indicated in the previous section the user can enable the Call Waiting Notification in order to receive incoming voice calls during an MPDS session. The enabling can optionally be restricted to specific phone numbers.

The 4-wire and 2-wire interfaces can be configured for usage for the Call Waiting Notification. When the notification arrives, the user is notified by a special ringing tone and a message is shown in the display if the 4-wire handset is selected for the service.

In case of an incoming call during an MPDS session with the Call Waiting Notification enabled, the user has three options:



- The user can **reject** the preemption of the MPDS connection by pressing  or  on the 4-wire handset (if enabled) or by taking an enabled 2-wire phone off hook, pressing  and placing the phone on hook again. The ringing stops on all handsets that are configured for the service.
- The user can **accept** the preemption of the MPDS connection by pressing  or  on the 4-wire handset (if enabled) or by taking an enabled 2-wire phone off hook, pressing  and placing the phone on hook again.  
The MPDS session is now deregistered and the call gets through after a short while. The phone to which the call is routed starts ringing and the call can be answered. Note that the call can be answered on another interface than the interface that was used to accept the call – e.g. a fax will normally only be routed to a specific RJ11 connector and not the 4-wire handset.
- The user may also choose to do nothing. After a certain time the notification stops and the preemption of the MPDS connection is implicitly rejected, if no other lines have accepted the notification.

Configuration of the Call Waiting notification is described in *Call Waiting Notification* on page 89.

# ISDN Connection

## Introduction

**Note**

The ISDN service is only available on Fleet55 systems when the vessel is positioned inside an area with Spot Beam coverage. On Fleet77 systems the services are also available in global beam. Though 128K can not be guaranteed by INMARSAT.

The Integrated Services Digital Network (ISDN) enables a bidirectional transmission of data to and from terrestrial **ISDN** networks.

The mobile ISDN service is charged by connection time. That makes the service feasible for transmissions that require a large data throughput.

The section *Setting up ISDN* on page 111 contains a description of how to setup an ISDN data connection on your PC.

## Supported services

The Fleet55 and the generic Fleet77 support a single B-channel (1 x 64 kbps Data) and one D-channel (control).

The Fleet77 optionally supports two B-channels (2 x 64 kbps Data). In order to enable this service a pin code is needed. This pin code can be retrieved from your distributor. As with other services the terminal needs to be commissioned to the 128 kbps service.

The terminal does not support dynamic switching between one and two B-channels. The user needs to decide whether to use one or two channels before establishing the call. The Fleet77 128 kbps service does not support mixed fixed and mobile originated calls, mixed UDI and voice calls nor the ability to close down one of the B channels dynamically.

For fixed originated calls, the terrestrial user is expected to dial the same INM number twice for each of the 64kbps calls.

Please refer to *ISDN interface* on page 16 for additional information about the ISDN interface.











# Operation

## Menu System

This section describes the functions in the menu system that are available to all users.

**The menu items concerning Distress/Priority call options are only present on Fleet77 systems.**

- To access the menu, press .
- To scroll through the menus, press  or .
- To enter the selected menu, press .
- To exit to the previous level in the menu system, press .
- To reach a specific menu item, press  and a number corresponding to the entry level. E.g. pressing   will access the 'Alarm Log' menu.
- To toggle shortcut numbers on and off, pressing  in the menu system.

The level of access to the menus is divided into 3 groups of users. A Normal User, a Super User and a Service User.

The **Normal User** has access to normal everyday functions.

A **Super User** has the same rights, but can additionally access different setup menus.

The **Service User** menu can only be accessed by the supplier or Thrane & Thrane. The Super User and Service User menus are protected by PIN codes.

A complete Menu Tree can be found in *Menu Tree* on page 155.

## Phonebook

### Overview

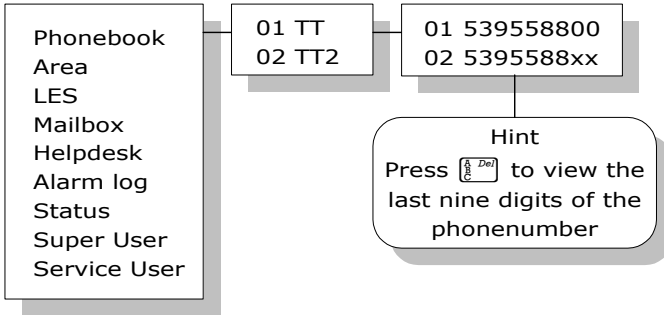

The terminal **PhoneBook** contains 99 entries. Each entry holds the following information:

- Name
- Telephone number
- Short code

The telephone number includes call prefix for automatic calls and international access code. The telephone number can hold up to 22 digits.

The name can hold from 0 to 16 characters.

### Short code

The short code can be used for quick access when dialing. To use the short code, press **\*** <short code> **#** and press **#** again to dial.

### Viewing and dialing from the phone book





The list of entries in the phone book is sorted according to short code.

An entry in the phone book is displayed as a short code and a name if in alpha mode or as a short code and a telephone number if in normal mode.

To select an entry, use  or  and press . The phone number is displayed.

Press  or  to dial.

## Priority

When the wanted number is displayed, press  to invoke the priority menu. Use  or  to select call priority (only on Fleet77). Press  or  to initiate the call.

For more information on how to make priority calls, see *Priority calls* on page 62.

## Inserting an entry

The following example shows how to insert an entry in the phone book from within the phone book menu.

In this example the number to Thrane & Thrane, 004539558800, is inserted with short code 14 and the name THRANE.

   
**THRANE**   
 0045 39558800   
 14 

## Editing or deleting an entry

To edit or delete an entry, select the entry in the phone book and press

  or   respectively.

## Area

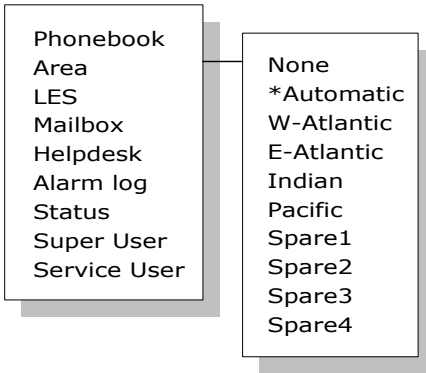

The **Area** menu is used to select ocean region and has the following list of possible choices:

- None
- Automatic
- W-Atlantic
- E-Atlantic
- Indian
- Pacific
- Spare 1
- Spare 2
- Spare 3
- Spare 4

The selected area is marked with an \*. If Automatic is selected the terminal will determine the area by scanning the sky and selecting the satellite with the best C/No. The selection is changed by choosing an area and then pressing



. Consult a coverage map to see the coverage areas for each ocean region.

## LES

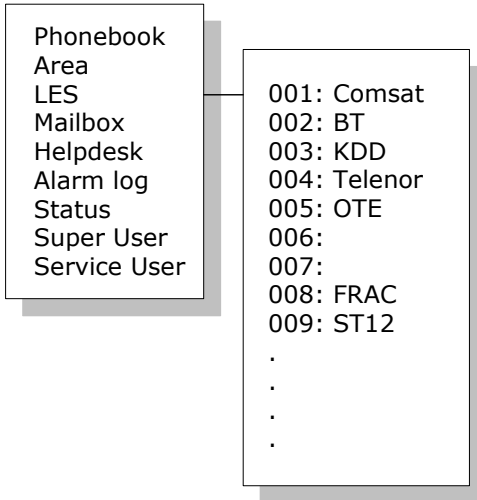

The **LES** list contains a list of those LES operators, which may be selected as gateway to the terrestrial network. The last used LES will be marked with \* and this LES will also be the first LES tried next time the terminal is logged on.

Use **OK** to select. The Area selected in *Area* on page 52, will decide which LES's will be available for selection.

See *LES Configuration* on page 85 for further information about LES configuration.



## Mailbox

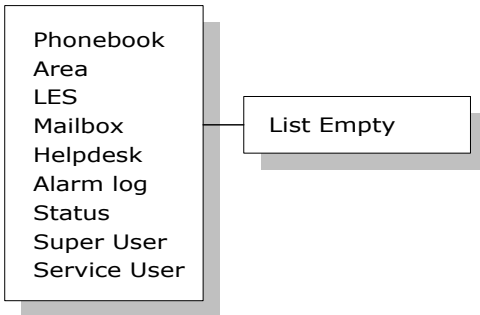

The **Mailbox** feature is not supported by all LES operators. The feature handles messages sent from the LES operator. If a call is made to a terminal which is busy, switched off, etc. the LES operator may offer the facility to record a short message. When the terminal becomes operational again, a message is sent indicating that the LES operator has recorded a short message for the terminal.

The  symbol in the handset display indicates the presence of such messages.

Each message can be seen in the **Mailbox** menu and contains the following information:

- LES Access Code
- Service type (voice, fax, data).

To view an entry, select the message and press . See how to delete a message in the section *Call Logs* on page 64.

## Help Desk

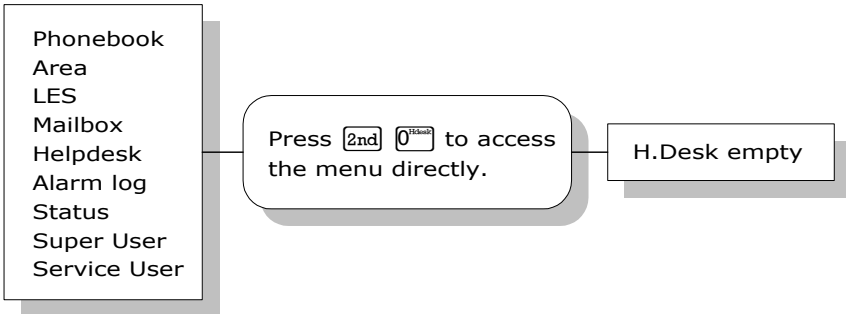

The **Help Desk** is a secondary phone book that can be used for storing up to 10 support phone numbers (e.g. Thrane & Thrane support centers).

Editing/inserting and deleting entries is done in exactly the same way as with the phone book, but it can only be done from the super user menu. Each entry contains a phone number, name of the entry, and a LES access code.

## Alarm Log

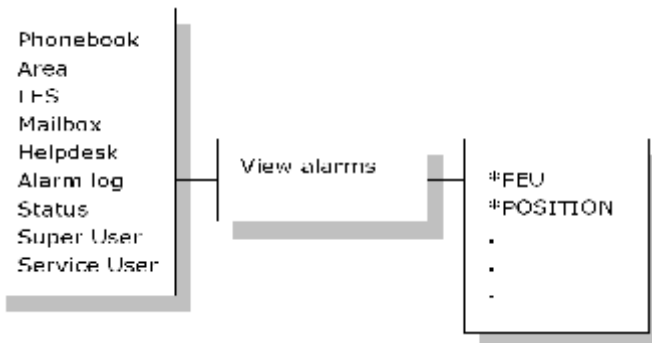

The **Alarm Log**, logs all the alarms in the system. From this menu the alarms can be viewed only. To clear the alarm list see *Alarm Log* on page 55. Scroll through the list using the **↑** *Edit* or **↓** *Audio* keys. An\* in front of the Alarm name

indicates that the alarm is still active. Select an alarm for viewing by pressing **OK**. Each entry for an alarm contains an alarm description and the time and date when the alarm occurred. See *List of Error messages* on page 133 for a list of alarms.

The alarm log can hold up to 20 entries. The log will wrap around when the log is full.

## Status

### Overview

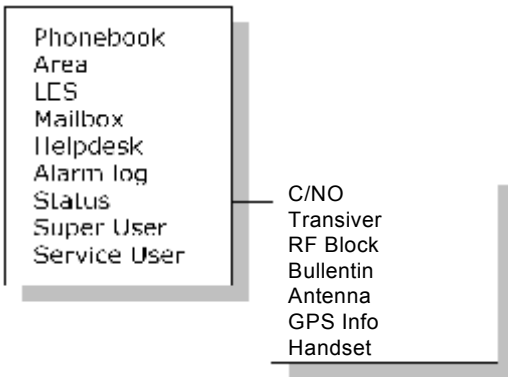

The **Status** menu has the following submenus:

- C/No
- Transceiver
- RF block
- Bulletin
- Antenna
- GPS
- Handset

## C/No

Choosing C/No will display the signal strength in dBHz. Pressing **Exit** will return to the previous state.

## Transceiver

- Release date: Software release date.
- Unit Type: Type of unit.
- Serial No.: T&T serial number.
- ISN: Inmarsat serial number.
- PCB No.: Serial number of main CPU board.
- Forward ID: The Forward ID number of the terminal.
- SW Ver.: Software version.

## RF Block

- RX Frequency: Receiving frequency in MHz.
- TX Frequency: Transmitting frequency in MHz
- Freq. offset: Frequency offset between 0-1500 Hz.
- Acc. offset: Acc offset between 0-1500 Hz.
- AGC: AGC between 0-1024.
- Gain: Gain between 0-256.
- TX level: TX level equals LOW or OK.
- Lo1-Lo3: Lox In or Out of lock.
- Temperature: Temperature in deg. C.
- Power mode: Power mode in sleep or normal.

### **Bulletin**

- Ocean Region: AORW, AORE, POR or IOR.
- NSR state: Not initialized, initializing or initialized.
- Type: Mini-M or NG
- Bulletin page 1-6: Page 1 to 255 or Invalid.
- Spot beam ID: Spot beam ID number between 1-255.
- SU CC Rxd: Between 0000-9999.
- SU CC Txd: Between 0000-9999.

### **Antenna**

The antenna information is divided into two parts: Front End Unit and Antenna Control Unit, and is primarily intended for service use.

#### **FEU:**

- Unit type
- Serial no.
- SW version
- Mode
- Power
- Temperature
- Cable loss
- Reset count
- Date

**ACU:**



- Unit type
- Serial no.
- State
- Input power
- Control Version
- Loader ver.
- FPGA ver.
- SU ver.
- RX2 ver.
- Loader CRC
- Control CRC
- FPGA CRC
- Config CRC





**GPS**

- PositionInfo: Not ready or Latitude and Longitude.
- Heading: Not ready, heading 0-360 degrees or  
Heading N/A Low speed (If speed is equal to or below 1 knot).
- Speed: Not ready or speed in knots.
- UTC Time: Not ready or YYYY:MM:DD HH:MM:SS
- Internal GPS: Not ready or Active and ready.
- External GPS: Not ready (for future use).

## Call functions





### Call using phone book

The phone book can be used to initiate a call, either by selecting an entry in the phone book and then pressing  or , or by using the short code.

To use the short code, press  followed by the short code. Pressing  afterwards will establish the call. Pressing  instead will show the actual number and the call can then be established by pressing  or .

Pressing  instead of  and , will invoke the priority menu. Use  or  to select call priority. Press  or  to initiate the call.

For more information on how to make priority calls, see *Priority calls* on page 62.

Short code 0 contains the last dialed number, thus   or   followed by  will redial the last number.

### Call from handset connected to RJ11

Making a call from a (normal 2-wire PSTN) phone connected to one of the three analogue RJ11 interfaces is done in the same way as a call from the handset. Just remember to press the  key to signal to the terminal that the number is complete.

Calling Thrane & Thrane in Denmark (country code 45) is done by pressing the following keys on the phone: 0045 39558800 

When using one of the RJ11 analogue interfaces please make sure that the selected interface is configured for a service, which supports voice (Mini-M voice, speech or 3.1 kHz audio). See *Routing* on page 66.

The display on the terminal handset will show how the call proceeds. After hanging up (on the 2-wire phone), the display will show how long the call lasted.

## Call from an ISDN phone

Making a call from a phone connected to the ISDN interface is done in the same way as a call from the handset. Just remember to press the  key to signal to the terminal, that the number is complete.

To call Thrane & Thrane in Denmark (country code 45), press the following keys on the phone:

0045 39558800 

The display on the terminal handset will show how the call proceeds. After hanging up (on the ISDN phone) the display will show how long the call lasted.

## Fax call

**Note** | This procedure is currently not functional in F55.

Fax calls can be made whether or not the fax has got a keypad.

Making calls from a fax with keypad connected to one of the three analogue RJ11 interfaces is done as international calls followed by . To call Thrane & Thrane in Denmark (country code 45) press the following keys on the fax:

0045 39558888 

Please make sure that the selected analogue RJ11 interface is configured for a service which supports fax (9600 fax or 3.1 kHz audio).

The display on the handset will show how the call proceeds.

After hanging up, the display will show how long the call lasted.





## Priority calls





**Note**









The Priority Call functionality is available on Fleet77 systems only.

A priority level can be selected when making a call. The priority levels are listed in the table below, where Routine-personal is the lowest priority and Distress is the highest.

Call Type	Priority level
Routine-personal	0-
Routine-professional	0+
Safety	1
Urgency	2
Distress	3

To make a Routine-personal call via the default LES, press the number and initiate the call by pressing  or .

To make a Routine-personal, Routine-professional, Safety or Urgency call using default LES, press the number followed by . Then use the  or  keys to select call priority and press  or  to initiate the call.

To make a priority call using a LES different from the default LES, press the number followed by . Use the  or  keys to select call priority. Press  to open the LES list. Use the  or  keys to select a LES and press ,  or  to initiate the call.

A Distress call can only be made by pressing the Distress button on the Distress Cradle. See *To make a Distress call.* on page 43.

## Internal calls

It is possible to make internal calls between any RJ11 (2 wire) interfaces.

To initiate the call, press the relevant interface code followed by .

The table below shows the interface codes.

Interface	Interface code	Interface port
RJ11 #1	2	X1
RJ11 #2	3	X2
RJ11 #3	4	X3
ISDN	5	X7

## Super User functions

This section contains a description of the items in the Super User Menu.

Please remember that  can be used to toggle short codes on and off.

### Call Logs

#### Menu overview

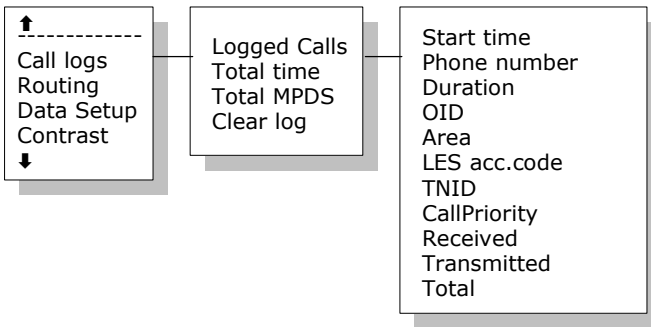

The **Call log** menu has got the following submenus

- Logged calls
- Total Time
- Total MPDS
- Clear log

## Logged calls

By entering the **Logged calls** menu it is possible to inspect information about each of the outgoing calls made on the terminal. The following information is logged for each call:

- Start time of call.
- Destination phone number.
- Duration of call
- Originating ID. (Description of service used).
- Ocean region used.
- LES access code.
- Terrestrial network identity (always 0).
- Call priority.
- Number of received bytes in MPDS.
- Number of transmitted bytes in MPDS.
- Total number of bytes in MPDS.

## Total time

**Total Time** shows the total accumulated call time since last reset.

## Total MPDS

**Total MPDS** shows the total accumulated number of bytes, used in MPDS sessions.

## Clear log

The call log can be cleared by selecting the **Clear Log** menu. Press **OK** to clear or **Exit** to abort.

The call log can contain up to 500 entries. After that it will start overwriting the oldest entry.

A warning is generated when the call log contains more than 470 entries. You may then back up your log data using Fleet CP PC software. If you also clear the log, you will get a warning again when 30 entries are left.

## Routing

### Menu overview

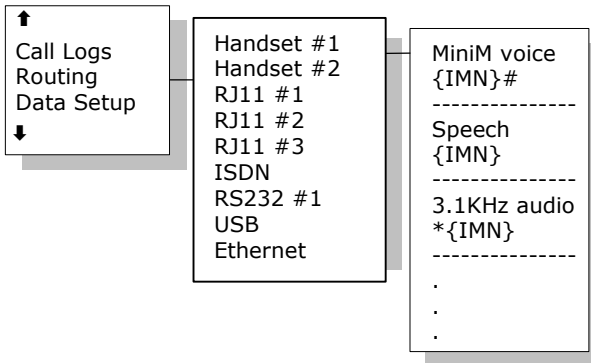

The Routing menu is used to associate the services with one or more interfaces. The menu has been divided into a number of submenus – one for each interface:

- Handset #1
- Handset #2
- RJ11 #1
- RJ11 #2
- RJ11 #3
- ISDN
- RS-232 #1
- USB
- Ethernet

## IMN numbers

### Note

The IMN-number has to be defined before the service can be routed to an interface. The service will not be listed in the routing table unless it has an IMN-number defined.

### Note

Some users want the IMN number to reflect the corresponding telephone number. In this case the user should EDIT the default IMN number. The INSERT function is only for adding additional IMN numbers. (or for creating the first IMN in case the list is empty).

When entering one of the above submenus it is possible to scroll through a list of all relevant IMN-numbers for the interface. In the handset menu, you will see all IMNs associated with voice: **Mini-M voice**, **Speech, 3.1 kHz audio**. The ISDN menu has the same, but in addition also the services **64 kbps** and **56 kbps** and, if enabled, **2x64 kbps** and **2x56 kbps**.

## Changing routing status

If an IMN has an incoming route to an interface it is marked with “\*”. If it has an outgoing route to an interface, it is marked with a “#”.

It is possible to change the routing-status for each IMN to the opposite by pressing  for incoming and  for outgoing.

## Routing an IMN to more interfaces

It is possible to route one IMN to more interfaces. E.g. an IMN can be routed to all three RJ11 interfaces at the same time. This will enable an incoming call to be routed to three 2-wire phones simultaneously.

### Routing matrix

The table below gives an overview of the routing matrix in the Fleet system. The Xs indicate which service can be routed to the specific interface.

Service	Interface				
	Handset	RJ11 (1, 2 & 3)	RS-232/ USB	ISDN	Ethernet
Mini-M voice	X	X		X	
9600 fax		X			
Speech	X	X		X	
3.1 kHz Audio	X	X		X	
64 kbps			X	X	
56 kbps				X	
MPDS			X <sup>a</sup>		X
2x64 kbps				X	
2x56 kbps				X	

- a. Please note that MPDS can only be associated with RS-232 and Ethernet - not the USB interface.

## Data setup

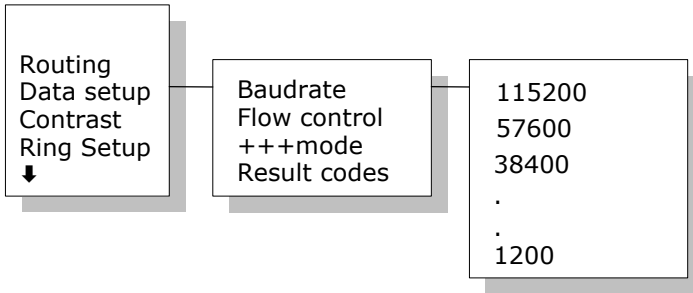



This menu is used to setup baud rate and data flow control for the RS-232 interface. The following settings can be configured.

- **Baudrate:** 115200-1200
- **Flow control:** None | Xon/Xoff | Hardware
- **+++mode:** Disabled | Enabled
- **Result codes:** Disabled | Enabled

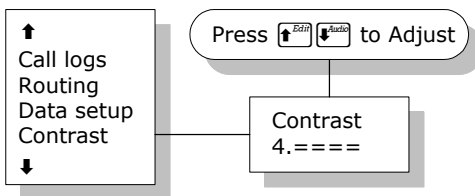
## Contrast



The display contrast of the two handsets can be adjusted. To change the contrast level, select the **Contrast** menu and adjust the value with  or . The contrast can be adjusted between 1 and 8. Default value is 4.



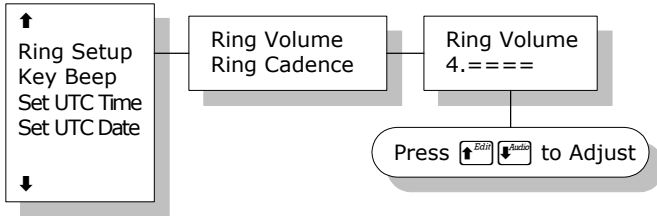

## Ring setup





**Ring setup** gives the possibility to change the ringing tone and the handset volume. Adjustable values are:

- **Ring Volume:** Off | 1 | 2 | 3 | 4, default is 4.
- **Ring Cadence:** 1 | 2 | 3 | 4 | 5 | 6 | 7, default is 1.

Both settings are adjusted with  or .

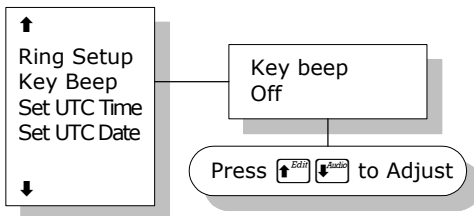
## Key Beep



**Key Beep**, the sound that is heard when a key is pressed, can be set to Off, 1, 2, 3 or 4. The setting is adjusted with  or . Key Beep is default off.

## Set UTC Time

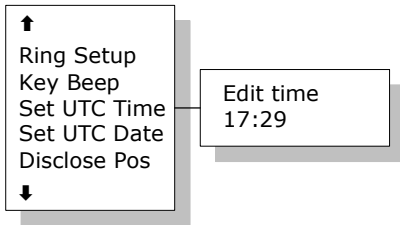

The current UTC time can be viewed and modified. The time is displayed in 24 hour format {hh:mm}. Enter a new time and press **OK** to update or **Exit** to cancel. If the clock is set to a non-UTC time a clock error message will appear after a while. By pressing **\***, the GPS time is automatically transferred. The clock error message can be cleared by **Exit**, but only for 24 hours, where the message will be shown again.

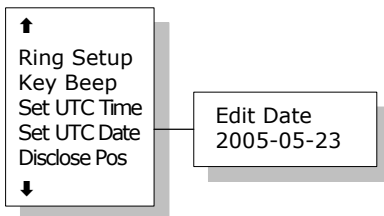

## Set UTC Date

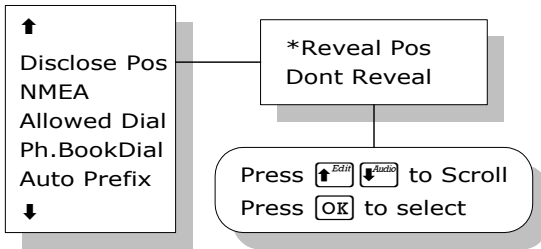

The current UTC date can be viewed and modified. The date is displayed in the format {yyyy:mm:dd}. Enter a new date and press **OK** to update or **Exit** to cancel. By pressing **\***, the GPS date is automatically transferred.

## Disclose Pos.



It is possible to disable the automatic reporting of position, from the GPS system. This menu gives the option to change this. Select **Reveal Pos** or **Don't reveal** with the  or  keys. Select the function with the  key. Current status is marked with an \*.

**Note** | Disabling automatic reporting of position means that the terminal will report spot beam ID instead.

**Note** | When a user initiates a maritime distress priority call, the position is reported regardless of the status of the automatic reporting.

## NMEA

NMEA. Not supported in this release.

## Allowed Dial

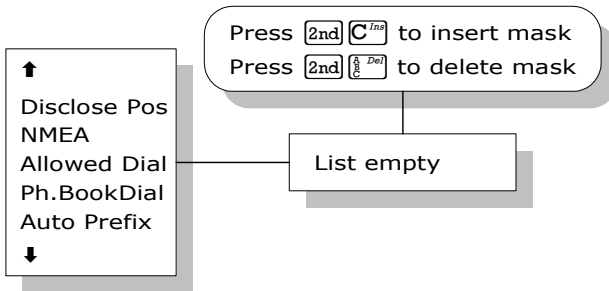

**Allowed Dial** is a function that allows the Super User to specify a phone number mask to restrict outgoing calls.

A phone number matches a dial mask, if the number contains at least as many digits as the mask and when the digits in the mask match the corresponding digits in the phone number, starting from the first digit.

Press **2nd** **C<sup>ins</sup>** to insert a mask and **2nd** **A<sup>Del</sup>** to delete a mask.

### Examples:

Mask: 00453955

Valid number: 004539558800

Valid number: 004539558888

Invalid number: 39558800

Invalid number: 004539

The terminal can contain up to 99 entries and each entry can be 22 digits long.

### Note

The phone number you enter in the dialer for making an MPDS connection is a dummy number that is not used. Therefore the “Allowed Dial” list has no effect on MPDS connecting.

## Ph.Book Dial

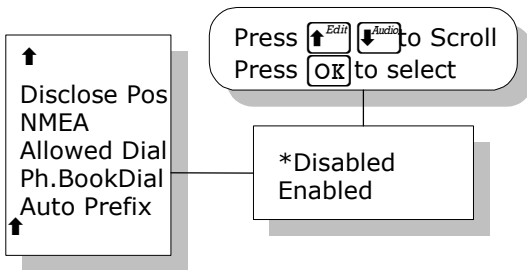

When this function is enabled, Normal User will only be able to make calls using the phone book or the Help desk from a SAILOR handset.

Use **[Up Arrow] [Edit]** or **[Down Arrow] [Audio]** to scroll between 'Enable' or 'Disable' and press **[OK]** to select.

The function is by default disabled.

## Auto Prefix

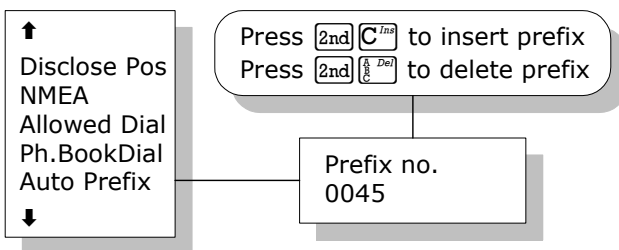

A prefix, e.g. 0045 for Denmark, can automatically be added to any dialed number. The prefix is not added to numbers dialed from the phone book. One prefix number with up to 22 characters can be defined. By default no Auto Prefix number is specified.

Press **[2nd] [C] [Ins]** to insert a prefix and **[2nd] [C] [Del]** to delete the prefix.

## BarServiceIn

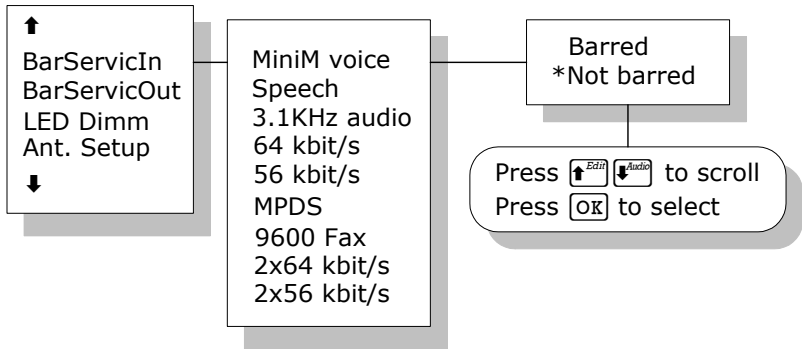

All incoming calls on a specific service can be barred. Scroll through the services with or . Select the service with . The service can then be set to **Barred** or **Not barred** with or and .

Please note the 2x56 and 2x64 kbps services are only visible if the 128 kbps is enabled.

Default setting is "Not barred" for all services.

## BarServiceOut

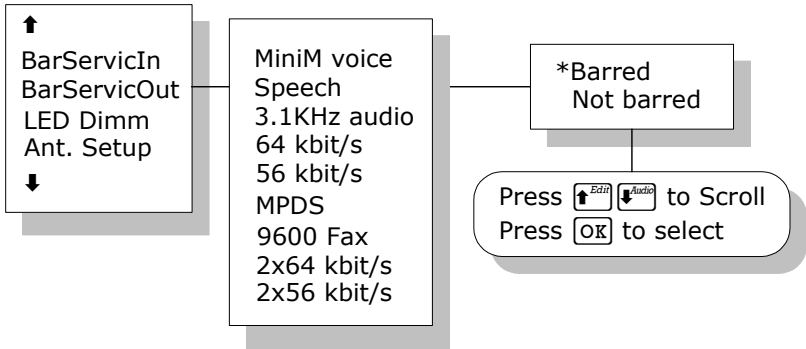

All outgoing calls on a specific service can be barred. Scroll through the services with Edit or Audio . Select the service with . The service can then be set to **Barred** or **Not barred** with Edit or Audio and .

Please note the 2x56 and 2x64 kbps services are only visible if the 128 kbps is enabled.

Default setting is “Not barred” for all services.

## LED Dimm

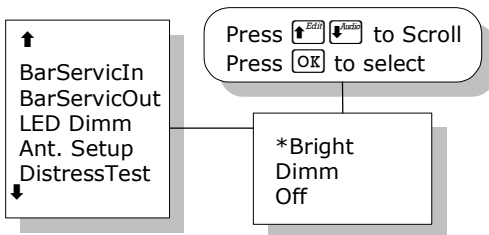

The brightness of the 4 LEDs on the two handsets can be adjusted. To change the brightness level, select the **LED Dimm** menu and adjust the value with

Edit or Audio . The brightness can be adjusted to **Bright**, **Dimm** and **Off**.

Default value is Bright.

## Antenna Setup

### Menu overview

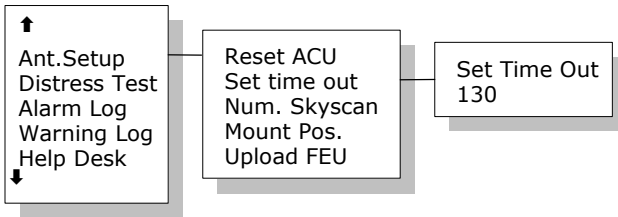

### Reset ACU

This function will reset the ACU in the antenna. The DC power running in the antenna cable will be turned off for a few seconds, causing the ACU to restart. This can be useful if the antenna control freezes or locks up.

### Set time out

This function sets the number of seconds the system waits without a satellite signal before it assumes the tracking is lost. Valid range is 1 to 300 seconds.

Default is 130 seconds. Confirm changes by pressing **OK**.

### Num. Skyscan

This function enables the user to define the number of sky scans. Valid range is 1 to 10 scans. Default is 1 scan. Confirm changes by pressing **OK**.



### ***Mount Pos.***

Because of the built-in GPS, the antenna is capable of finding the satellite within a few seconds. However, a heading of the ship is also needed. Because the GPS does not supply the antenna with this information, you must enter a relative angle of the antenna compared to the ships bow. Valid angles are 0(REAR), 90(PORT), 180(BOW), and 270(STARBOARD) deg, positive in a clockwise direction. Default angle is 0 deg. Confirm changes by pressing



### ***Upload FEU***

If a new FEU (Part of the antenna) is installed, this command will upload software to the FEU, thereby pairing the software in the BDU and FEU. If the FEU software version in the antenna is different from the version that is stored in the BDU, you will get a warning. You may then use the "Upload FEU" command to remove this difference.

## Distress Test

**Note** | The Distress Test functionality is available on Fleet77 systems only.

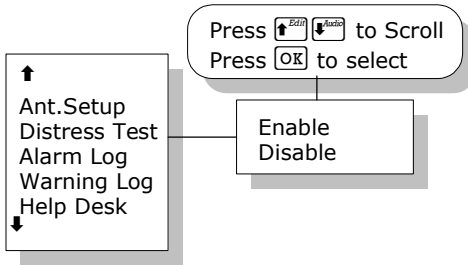

A **Distress Test** is made to test the Distress call system. When the RCC receives the call, a flag in the message is set, so that the RCC can identify the call as a test call. Follow this Distress Test procedure:

1. Enter the DistressTest menu and use or and to enable distress test. The display on the handset will show 'Distress Test Enabled' and the Distress Test LED will start flashing.
2. The Distress test mode remains active in 30 seconds, after which it automatically disables the test again. While the distress test is enabled, press the Distress button on the cradle for 5 seconds or until the light on the button stops flashing and the buzzer stops beeping.
3. All ongoing calls will be preempted after 15 seconds .
4. A list of distress LES's is presented in the handset display. Use or and to select a LES. If a LES is not selected within 15 seconds, the pre-configured LES will be selected instead.
5. The handset display will now go from 'Distress calling' to 'Distress connected' as the call progresses. 'Distress connected' also means that the test was a success.
6. To abort the test call press or wait 120 seconds, after which the call will automatically be disconnected.

## Alarm log

### Menu overview

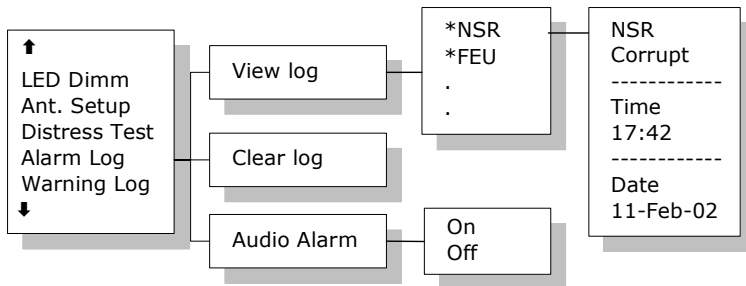

The **Alarm Log**, logs all the alarms in the system. From this menu, the alarms can be viewed and cleared. The alarm log can contain up to 20 entries. When the log is full, the oldest alarms are deleted.

### Clearing the alarm log

To clear the alarm list, select **Clear log** and confirm the message `Delete all?` by pressing **OK**.

### Viewing the alarm log

To view the alarm log, select **View log**. Scroll through the alarm list, using the **Edit** or **Audio** keys. A \* in front of the alarm indicates that it is still active.

To select an alarm for viewing, press **OK**. Each entry for an alarm contains an alarm description and the time and date when the alarm occurred. See *List of Error messages* on page 133 for a list of alarms.

### Audio alarm

You may get an audio alarm when an alarm is added to the alarm log. This may be turned on and off by entering the **Audio Alarm** menu.

## Warning Log

### Menu overview

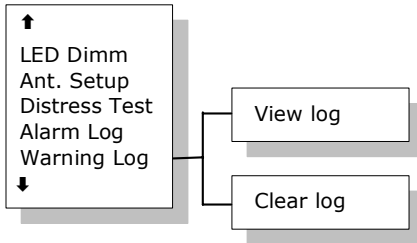

The Warning Log logs the warnings in the system. Warnings are not as critical as alarms. From this menu, the warnings can be viewed and cleared.

### Clearing the warning list

To clear the warning list, select **Clear log** and confirm the message `Delete all?` by pressing **OK**.

### Viewing the warning log

To view the warning log, select **View log**. Scroll through the warning log using the **↑** Edit or **↓** Audio key. A \* in front of the warning name indicates that the warning is still active.

To select a warning for viewing, press **OK**. Each entry for a warning contains a warning description and the time and date when the warning occurred.

## Help Desk

Help Desk. Please refer to *Help Desk* on page 55.

## PIN codes

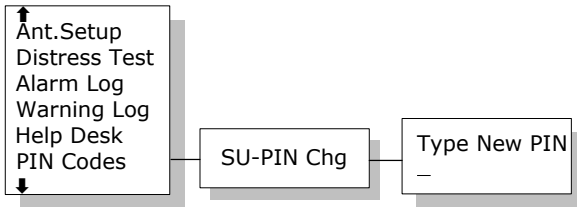

The **PIN codes** menu is where the Super User PIN is changed. For a description of the pin codes, see *Use of PIN codes*. on page 39. The **PIN codes** menu has the following submenu.

**SU-PIN Chg:** The Super User PIN is changed here. Type in the new PIN and press **OK** to accept the change. Retype the new pin and press **OK**. It is not possible to enter a SU-pin code identical to the service user pin !

## Mailbox

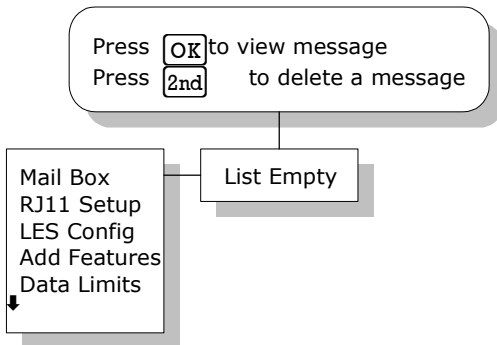

The **Mailbox** feature handles messages being sent from the LES operator. If a call is made to a terminal that is busy, switched off, etc. the LES operator may offer the facility to record a short message. When the terminal becomes operational again, a message is sent indicating that the LES operator has recorded a short message for the terminal.

The  symbol in the handset display indicates the presence of such messages.



Each message can be seen in the **Mailbox** menu and contains the following information:

- LES Access Code
- Service type (voice, fax, data).

The following operations are possible:

- View entries
- Delete entries.



To View an entry, select the message and press .

To delete an entry, select the message and press  .

## RJ11 Setup

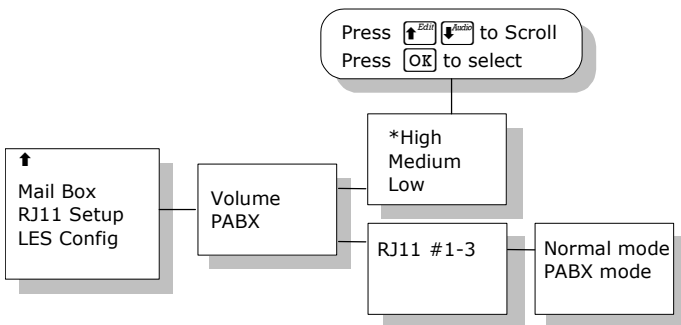
### Overview



The **RJ11 Setup** menu contains the two submenus **Volume** and **PABX**. Use  or  and  to select among them.

## Volume

2-wire phones connected to the RJ11 interfaces may vary in sensitivity. As a consequence the output volume from the interfaces can be adjusted. The volume can be set to **High, Medium** or **Low**.



Adjust the setting with  or  and select with . The default value is **High**.

Press  to leave the submenu.

## PABX

When you select **PABX** (Private Automatic Branch eXchange) a submenu appears where RJ11 #1-3 can be selected. Each of these can be set in **Normal mode** and **PABX mode** (default is **Normal mode**).

If a PABX is to be connected to an RJ11 connector, select **PABX mode**.

Use  or  to toggle the values and  to select.

Press  to leave the submenu.

## LES Configuration

### Overview

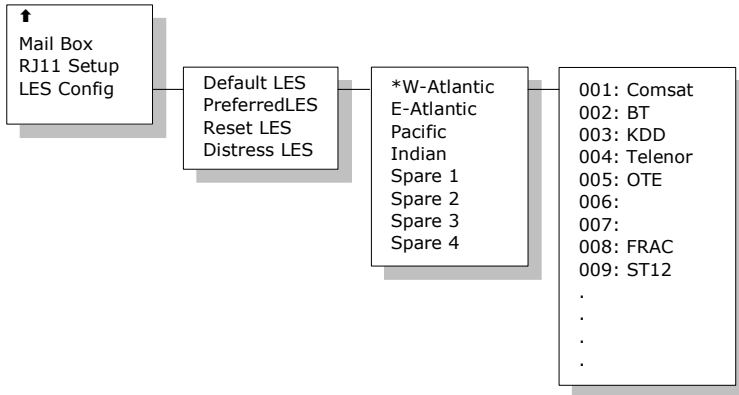

#### Note

The Distress LES functionality is available on Fleet77 systems only.

This menu is used to select a list of LES operators. It contains the following submenus:



- Default LES
- PreferredLES
- Allowed LES
- Reset LES
- Distress LES

### Default LES



The **Default LES** list contains a list of the LES operators that may be selected as gateway to the terrestrial network. The last used LES will be marked with \* and this LES will also be the first LES tried next time the terminal is logged on.



If there is no LES list selected under Allowed or Preferred LES, the Default LES list will contain the LES list from the satellite bulletin board, meaning all



available LESs in the selected Ocean region. Use  **Edit** or  **Audio** and  to select an Ocean region and then a LES.

To **edit** the LES names in the **Default LES** list, select the name and press



  **Edit** to start editing the selected name.



To **clear** the name, press  .

An **Allowed LES** list can be selected under the Service User menu. If an Allowed LES list exists, only the LESs in this list can be selected under Default and Preferred LES. An Allowed LES list contains all available LES operators in the selected ocean region. The operators marked with \* can be used as Default LES operators and thus appear in the Default LES list above. If all LES operators are allowed and can be used there are no markings.

### Preferred LES

As there are many operators, you can use **PreferredLES** to make selections easier. The Preferred LES list can be used to indicate in which order LES operators should appear on the Default LES list.

Press   for each LES intended to be on the list, in the order they should appear in the Default LES list.



A prompt for a TNID will appear in the handset display. This value is usually 0, but in some countries with more than one terrestrial network, the TNID can have another value. To accept the default TNID, press . Press  again to update the preferred LES list.

To remove a LES from the list, press   and then  to update the list.

### Reset LES

The **Reset LES** command resets all the LES names to default names.

## Distress LES

The **Distress LES** list contains a list of the LES operators which may be selected when making a Distress Priority Call. Use  or  and  to select an Ocean region and then a LES.



### Note

If a Distress LES is not defined for each Ocean Region, an alarm will appear and the entry 'Distress LES is not selected in all Ocean Regions' will be added to the alarm log.

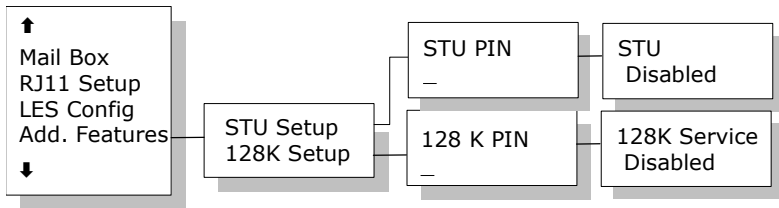
## Additional Features



The Additional Features menu contains two submenus **STU Setup** (Secure Telephone Unit) and **128K Setup**. To enable the STU or 128K services a PIN code must be entered. The PIN code can be retrieved from your distributor.

Use  or  and  to choose **STU Setup** or **128K Setup**.

If the PIN code is successfully entered you can enable or disable the service.

Use  or  to toggle and  to change.

Press  to leave the submenu.

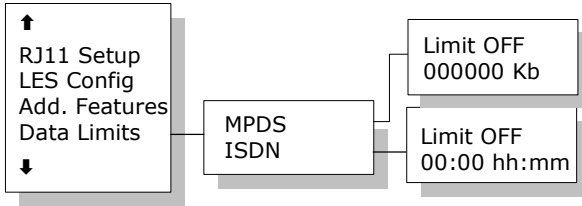

## Data Limits

### Overview



The Data Limits menu enables the user to enter an upper limit for the use of each high speed connection. This feature is an effective way of preventing that a user by mistake forgets to close a connection.

The Data Limits menu contains two submenus **MPDS** and **ISDN**.



Use  or  and  to select among them.

### MPDS

The **MPDS** submenu contains two parameters: **Limit** and a **value** for the maximum allowed amount of kilobytes that can be transferred in each call.

**Limit** can be either **ON** or **OFF**. If set to **ON** the MPDS connection will automatically be closed down if the transferred amount of data exceeds the entered maximum value. If set to **OFF**, there will be no limits for the amount of data that can be transferred.

Use  or  to select **Limit** and  to manipulate.



To enter a maximum limit press  again. Then use the numeric keys to enter a value and press  to save. Press  to leave the submenu.

### ISDN

The **ISDN** submenu contains two parameters **Limit** and a maximum duration for each call. **Limit** can be either **ON** or **OFF**. If set to **ON** the call will

automatically be closed down if the call has lasted longer than the entered maximum duration. If set to **OFF**, there will be no boundaries on the call duration.

Use  *Edit* or  *Audio* to select **Limit** and  to manipulate.



To enter a maximum call duration press  again. Then use the numeric keys to enter the duration in hours and minutes and press  to save. Press  to leave the submenu.

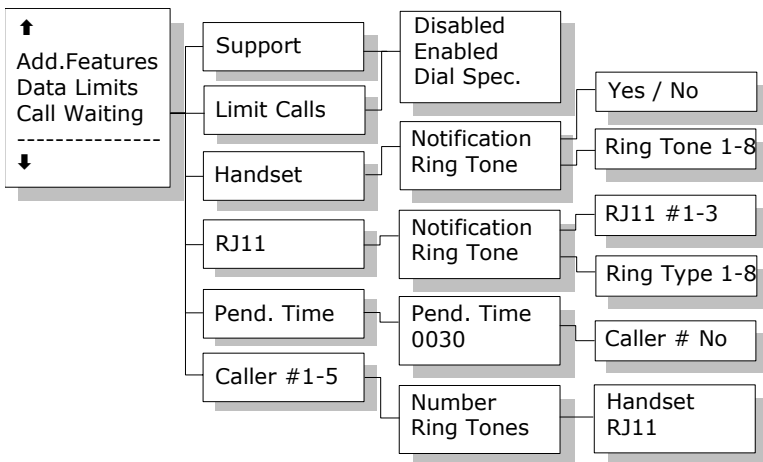

## Call Waiting Notification

### Overview



The Call Waiting menu contains a number of submenus.

Use  *Edit* or  *Audio* and  to select among the submenus.

Press  to save the changes and press  to leave a menu. Please refer to *Call waiting* on page 45 for general information about the Call Waiting Notification.

## Support

The **Support** menu is used for enabling or disabling the Call Waiting Notification service. A third option **Dial Spec.** makes it possible to control the **Support** setting using the AT shell command<sup>1</sup>. Choose the settings by pressing

**OK** and press **Exit** leave the menu.

## Limit Calls

The user may not want all calls to interrupt the MPDS sessions. It is possible to enter up to five phone numbers that are allowed to interrupt the MPDS sessions while all others will be rejected. If **Limit Calls** is set to **Enabled** only the five phone numbers are allowed to interrupt. If **Limit Calls** is set to **Disabled** all calls are allowed to interrupt. The third option **Dial Spec.** makes it possible to control the **Limit Calls** setting using the AT command<sup>2</sup>. Please note that the **Limit Calls** service is not supported by the LES at present time.

However, it will most likely be available in near future. Choose the settings by pressing **OK** and press **Exit** leave the menu.

## Handset

The **Handset** menu contains two sub items: **Notification** and **Ring Tone**.

**Notification** can be either **Yes** or **No** and it controls whether or not the 4-Wire Handset should be used for Call Waiting Notification.

**Ring Tone** can be used for choosing among the 8 Ring Tones. Select the

settings by pressing **OK** and press **Exit** leave the menu.

- 
1. If Dial Spec. is chosen, support of Call Waiting Notification can be controlled using the AT shell command **+WCWNS=<value>** during the MPDS call setup. Possible values for the AT shell command are: 0 = DISABLED, 1 = ENABLED, 2 = AUTOMATIC.
  2. If Dial Spec. is chosen the Limit Calls setting can be controlled using the AT command **+WCWNR=<value>** during the MPDS call setup. Possible values are: 0 = DISABLED, 1 = ENABLED.

## RJ11

The **RJ11** menu contains two sub items: **Notification** and **Ring Tone**.

**Notification** can be either **Yes** or **No** for each of the three RJ11 2-wire connectors.

**Ring Tone** can be used for selecting a common 2-wire ring tone among eight ring tones. The ring tones are described with the two symbols '#' (sound) and ' ' (no sound). Select the settings by pressing **OK** and press **Exit** to leave the menu.

## Pending Time

The **Pending Time** is set to 30 seconds by default. The Call Waiting Notification will continue for a number of seconds corresponding to the value of **Pending Time**. If the user chooses to ignore the notification for a longer period the incoming call will be ignored.

Enter a value and press **OK** to save when leaving the menu. Press **Exit** to leave the menu without saving.

## Caller #1-5

Each of these items (#1-5) can contain a phone number that is allowed to interrupt the MPDS sessions, if this function is enabled in the menu item **Limit Calls**.

Each number can be individually associated with a ring tone and with the 4-Wire handset and/or a number of the RJ11 2-Wire connectors. Configuration is done as described in the menu items **Handset** and **RJ11**.

## I/O Setup

### Overview

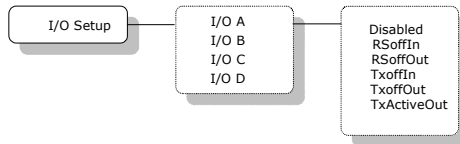

Each input/output pin can be configured to one of these functions:

As input types: TxOffIn, RSOffIn

As output types: TxOffOut, RSOffOut, TxActiveOut

- |              |  |
|--------------|--|
| TxOffIn:     | Input activates TxOff functionality.           |
| RSOffIn:     | Input activates Radio Silence functionality.   |
| TxOffOut:    | Output indicates that TxOff is active.         |
| RSOffOut:    | Output indicates that Radio Silence is active. |
| TxActiveOut: | Output indicates that Transmit is active.      |

Each input or output pin can be configured as either active high or low.

**TxOff (Transmit Off):**

When this function is active the terminal will stop all transmission from the antenna by terminating the call as it is normally done. Distress alarms from ship or from land will be allowed.

**RS (Radio Silence):**

This function has higher priority than the Transmit-Off function. If this function is active any transmission from the antenna will be blocked. Even distress calls in both directions will be prohibited.

Both functions can only be activated by the discrete I/O pins. The pins have to be configured from the Super User menu, which can only be accessed by entering a password.

# PC programs

## System set-up using FleetCP

### Overview

System set-up can be managed from a PC program called **FleetCP**, instead of from the handset. **FleetCP** can be installed from the enclosed CD-ROM. The following pages contain a short introduction to **FleetCP**. The picture below shows the initial screen, when the program is started.

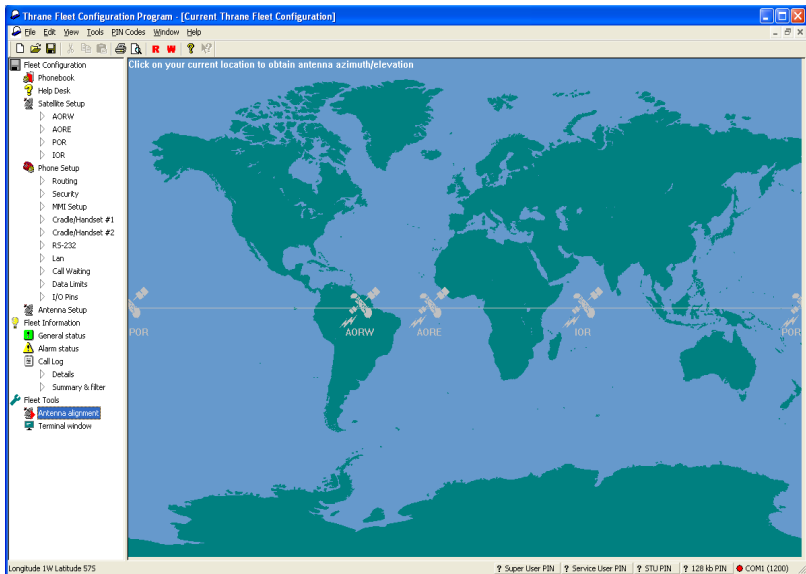

Connect the transceiver to a PC using a standard RS-232 connection.

When connected, The FLEETCP will automatically download the information from the fleet to the PC. It is also possible to click the red **R** button on the top toolbar to read the current configuration from the terminal. Click the red **W** button to write any changes to the terminal.



Select the functions by clicking in the left menu window. The menu window is divided into the following groups: Phonebook, Help Desk, Satellite setup, Phone Setup, Antenna Setup, General Status, Alarm Status, Call Log, Antenna Alignment and Terminal Window.

## The Map

Clicking the map will show the Azimuth and Elevation to the satellites reachable in that area. See picture below.

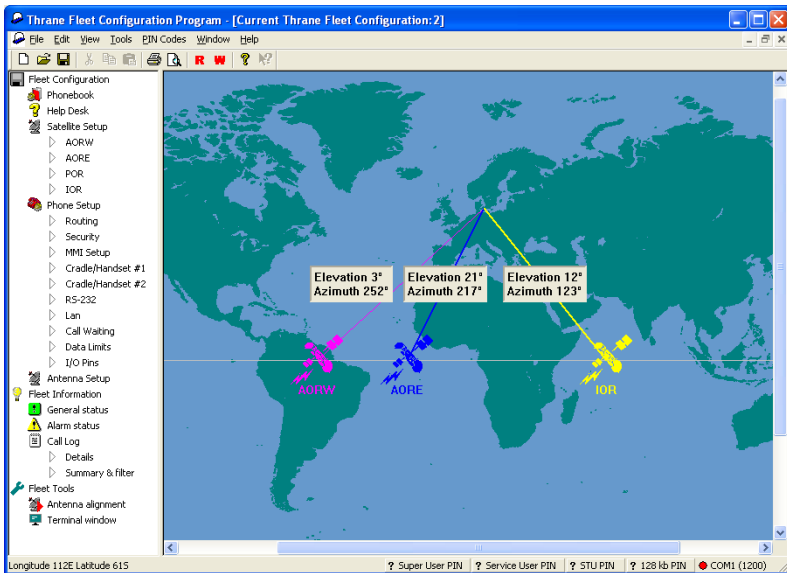

The status bar in the lower part of the window shows longitude and latitude as the cursor is moved around the screen.

## Pin codes

The right side of the status bar shows the status of the PIN codes. If no PIN codes are entered, all lock icons will be red and locked. Click the appropriate button to enter or change a PIN code. See the picture below.

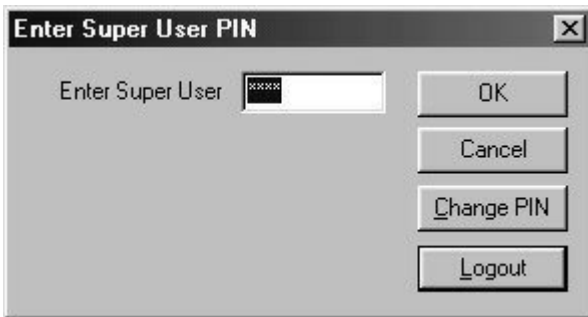

When a correct PIN is entered, the lock icon will become unlocked and turn green. At the same time a new logout button will appear next to the PIN code buttons. Click this button to reset the status of all PIN codes.

If a change to the configuration is made without entering a PIN code first, a popup asking for the PIN will appear when the **Write** button is pressed. See below.



To read more about PIN codes see *Use of PIN codes*. on page 39.

## Phonebook

To enter new Phonebook entries, select **Phonebook** and right-click in the phone book area. Entries here can be modified or deleted in the same way. See the picture below. For further information, see *Phonebook* on page 50.

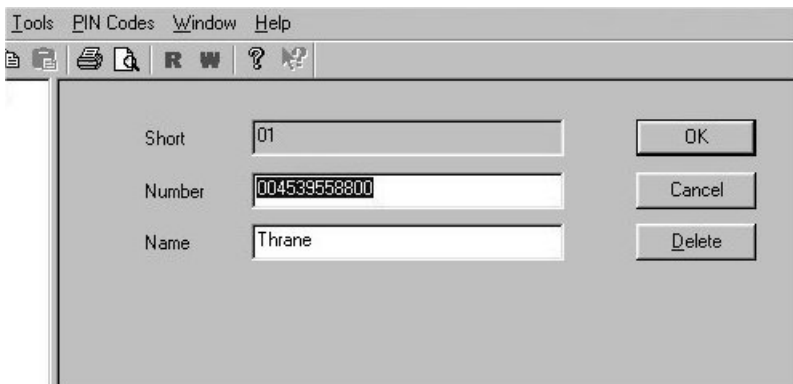
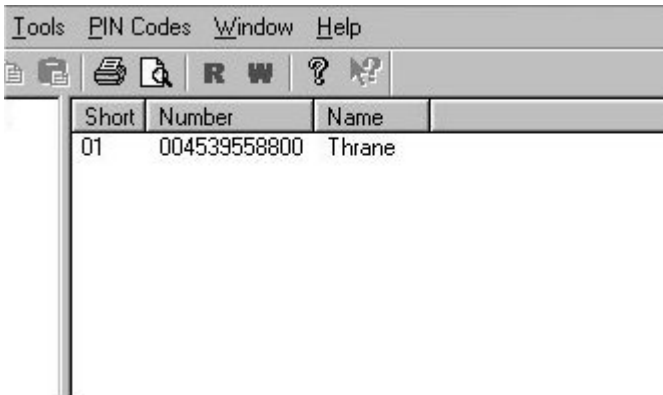

Inserting, editing and deleting entries in the Helpdesk works in a similar way. See the Installation Manual for further information.

## Satellite Setup

To enter the Satellite Setup window, select **Satellite Setup** in the left menu and select the ocean region you want to set up.

Satellite Setup offers an easy way of setting up Allowed, Preferred and default LES. LES operators are dragged and dropped between the three tables. See the picture below.

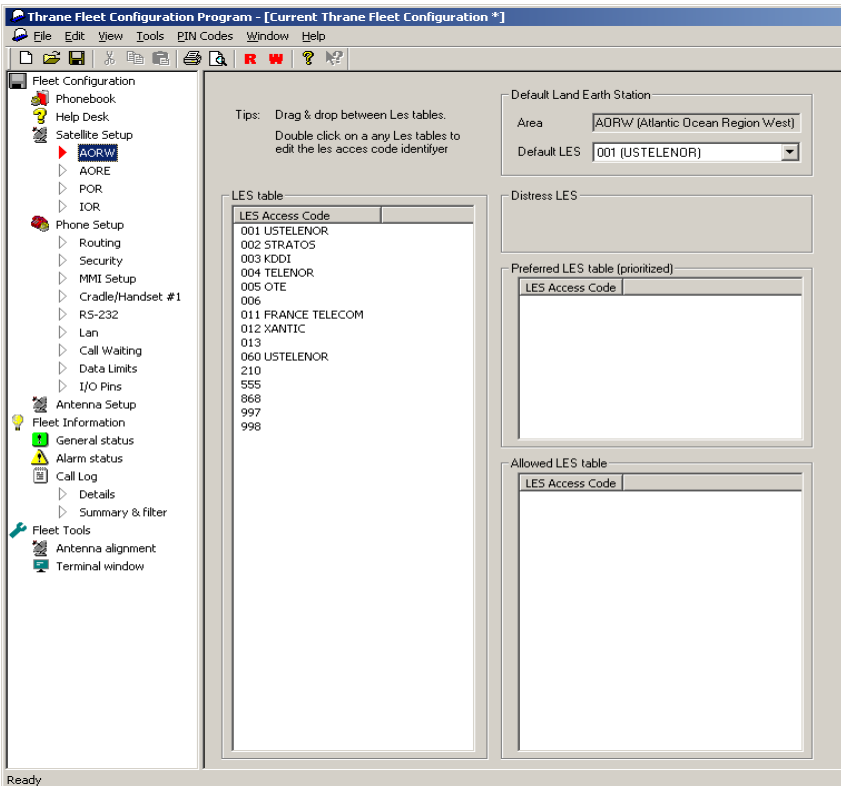

Read more about LES configuration in *LES Configuration* on page 85.

## Phone Setup

### Routing

To route calls, select **Phone Setup > Routing** from the left menu and use the table.

Click in the cell that corresponds to the service/interface that is to be changed. Click the \* (incoming) or # (outgoing) button in the lower part of the screen to define it as an incoming or outgoing call. To add an IMN, click the **New IMN/ID** button. See the picture below.

Call / device routing - Note: MPDS is NOT supported under USB

Service	IMN	ID	Handset #1	Handset #2	Rj11 #1	Rj11 #2	Rj11 #3	RS-232	ISDN	Ethernet
mini-M voice	1	01h	* #	#	#	#	#		#	
9.6 kbit Fax	3	16h								
Speech	4	91h	*							
3.1 kHz audio	2	61h	*							
64 kbps UDI	8	51h								
2x64 kbps UDI	11	86h								
56 kbps UDI	7	71h								
2x56 kbps UDI	10	88h								
MPDS	9	A1h						*		#

**Legend**  
 \*: Activate on incoming calls    #: Use this service for outgoing calls (max. one per column)

**Additional Feature**  
 128 kbps services        Note: The feature requires special pin.

See *Routing* on page 66 and *IMN Config* in the Installation manual for a detailed explanation about routing, IMN and IDs.

## Setting up time and date

To correct the time/date or the language (future option), select **Phone Setup > MMI Setup**.

Click the **Use PC time** button to import the time and date from the PC clock. If the clock is set to a non-UTC time a clock error message will appear on the 4-W handset on the transceiver after a while. Click **OK**.



### Barring services

In the **Security** window call restrictions can be enabled or disabled and an Auto prefix inserted.

Select **Phone Setup > Security** to enter the Security window.

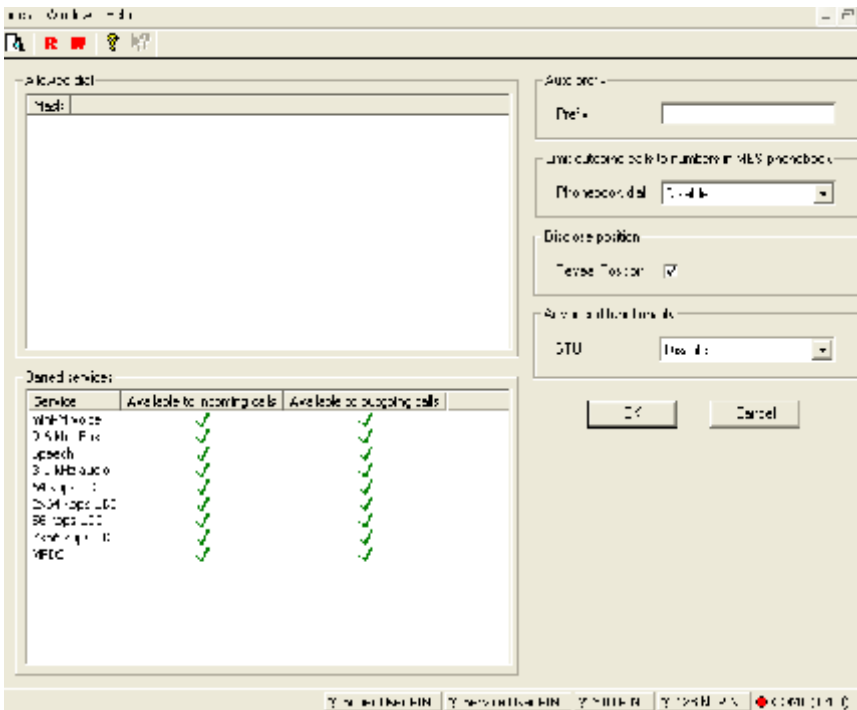

See the sections *Allowed Dial* on page 73, *BarServiceIn* on page 75 and *BarServiceOut* on page 76 for more details.

## Settings

In the Cradle/Handset window it is possible to setup ring type, ring volume, LED brightness and display contrast.

Select **Phone Setup > Cradle/Handset #1** or **#2** to enter the Cradle/Handset window.

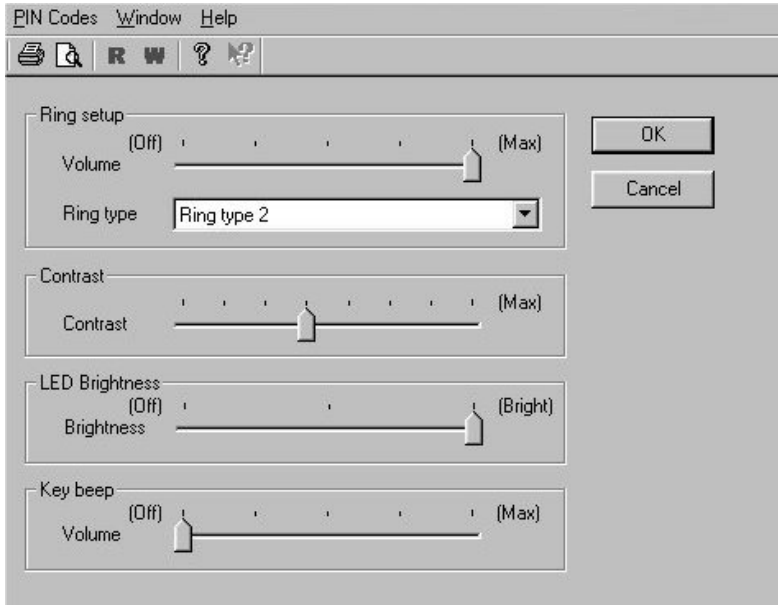



RS-232 parameters of the terminal can be changed in the RS-232 window. Select **Phone Setup > RS-232** to enter the RS-232 window.

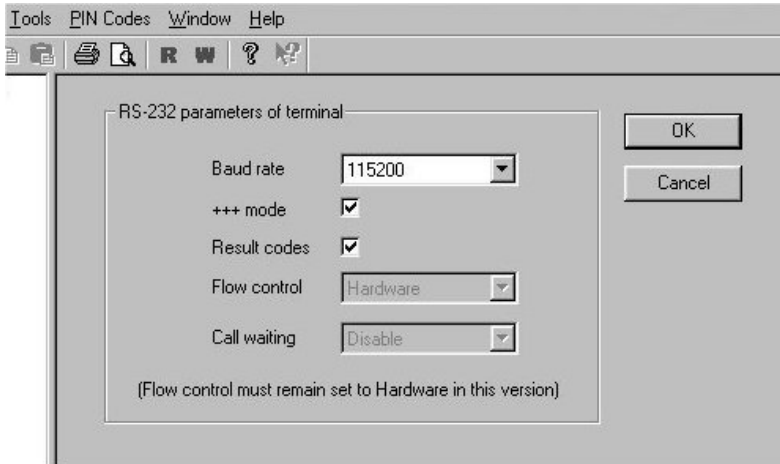

## Antenna

Select **Antenna Setup** from the left menu to change Long term failure timeout, number of allowed sky scans and the antenna's mount position relative to the ship's bow. See *Antenna Setup* on page 77 for details.

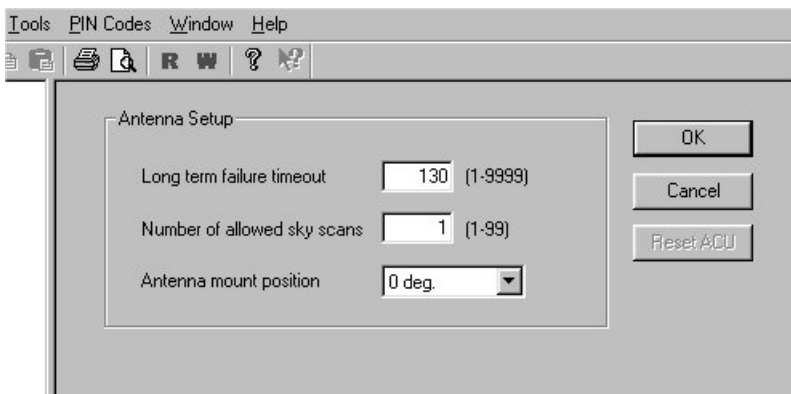

The antenna can be rebooted by clicking the **Reset ACU** button.

## Terminal window

The terminal window makes it possible to run AT commands in the same way as the Windows program HyperTerminal.

Select **Fleet Tools > Terminal Window** from the left menu to access the terminal window.

## Setting up data equipment

### Setting up MPDS over RS-232

#### *MPDS hardware connection*

The illustration below shows typical hardware setup for an MPDS data connection.



For an MPDS session, connect an RS-232 cable between the COM port of the computer and the COM ports on the Fleet system. The COM port on the Fleet system is marked X10.

This setup procedure is intended for PCs running a MS-Windows operating system.

The PC communicates with the transceiver as if it were a modem. Connect the transceiver to a COM port via a standard RS-232 cable.

#### ***Configuring the TT-3084A, TT-3084B & TT-3086A***

The transceiver has to be configured for the right ocean region and LES operator that provides the MPDS service. This is done using the handset user interface.

The RS-232 configuration of the transceiver should be (using the handset user interface, see *Data setup* on page 69):

Baud rate: 115200 baud

Flow control: Hardware

### Setting up your PC

This section describes in general terms how to set up an MS-Windows based PC, covering Windows 95, 98, 2000 and NT. The screen dumps below are from Windows 98. For a detailed description with more screen dumps of the installations, you are referred to the Application Note “Configuring SAILOR Fleet77 for MPDS” on your MES Software distribution disk or at our web site [www.thrane.com](http://www.thrane.com).

#### Step 1: Install a standard modem

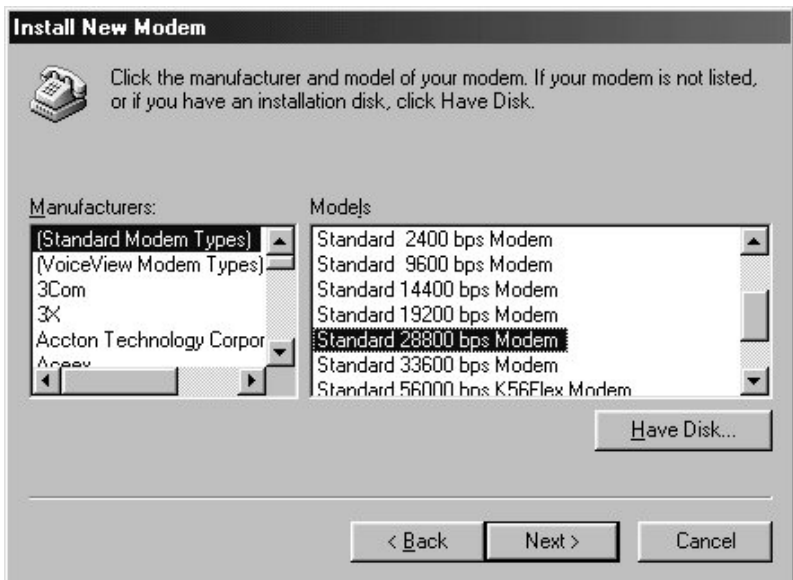

1. From the **Control Panel** select **Modems** and add a Standard modem. Do not let Windows detect the modem, but manually select a standard 28800 bps Modem.

2. Select the appropriate COM port (i.e. the COM port that is connected to the terminal).
3. Set maximum speed to 115200.
4. Set Data bits = 8, Parity = None and Stop bits = 1.

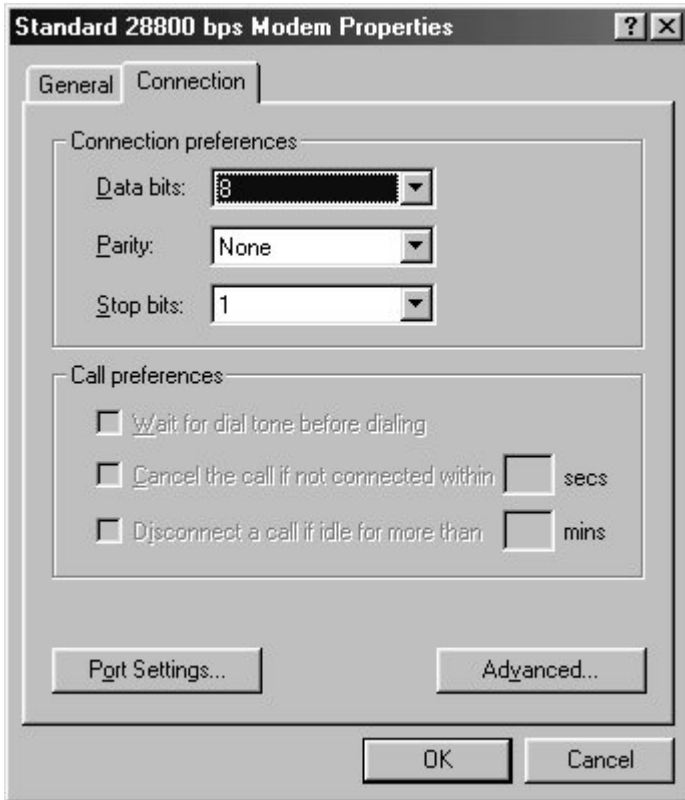

5. **Important:** Enter **Advanced settings** and type the initialization command **AT+MPDS** in the **Extra settings** field.

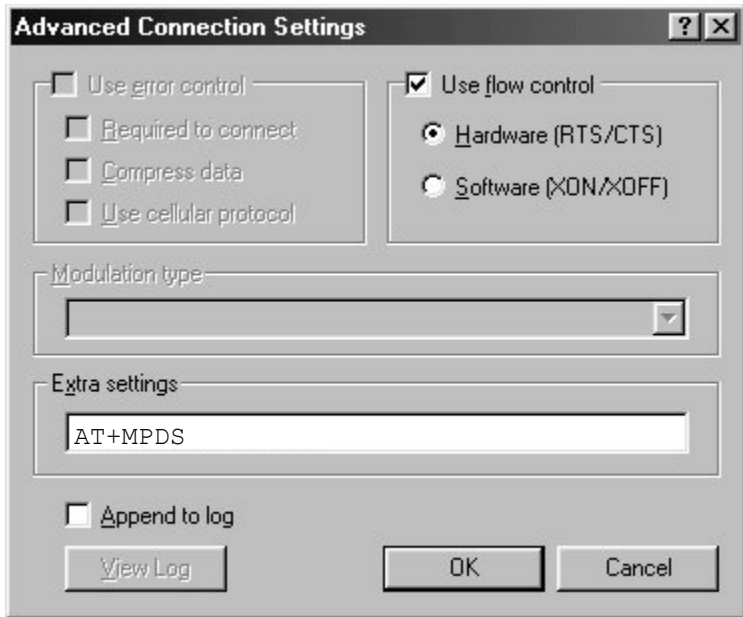

This string is transferred to the terminal when setting up a connection.

If the MPDS connection is to use another LES than the one already selected, use the initialization command = **AT+MPDS;+WLES=XXX**, where XXX is the LES number. **+WLES=XXX** is only needed if MPDS LES is different from default LES.

6. If the terminal is to stay in MPDS mode with no activity for longer periods of time, the automatic “disconnect when idle” setting in Windows must be disabled. Refer to your Windows manual on how to do this.

AT+MPDS

### **Step 2: Create a Dial-up connection**

1. Open **Dial-up Networking** from **My computer** and click **Make new connection**.
2. Select the standard modem defined during step 1 as the dial up device.
3. Enter a dummy telephone number (the number is not used but has to be defined – write e.g. “123” as the phone number).
4. Give the connection a recognizable name e.g. MPDS connection, and click **Next >**.

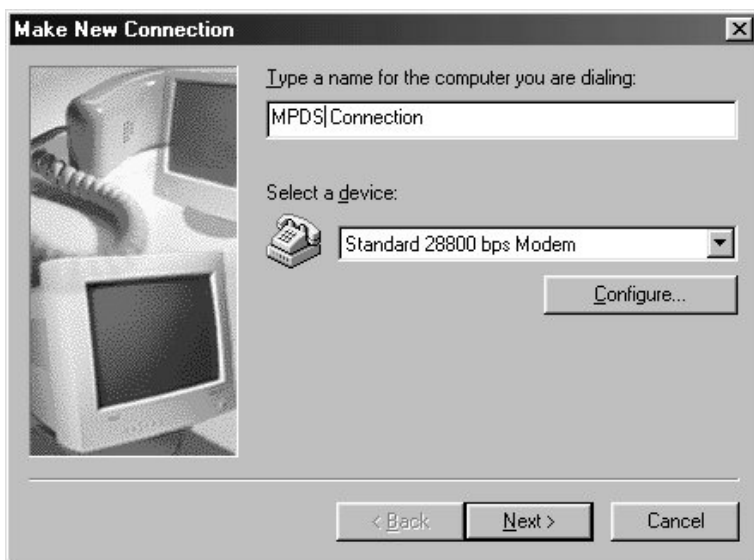

5. Include TCP/IP as allowed network protocol and use default TCP/IP settings (Server assigned IP address, Server assigned name server addresses etc.).

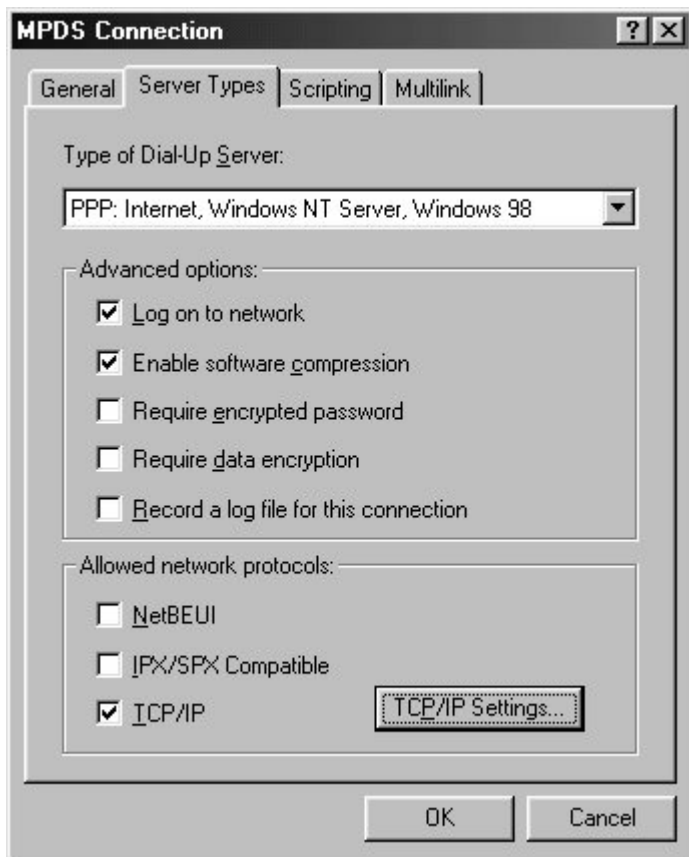

6. Click OK.



An MPDS connection can be started automatically by an application like Internet Explorer or Outlook Express. The connection can also be established manually as follows:

1. In Windows, open **Dial-Up networking** and double click the appropriate icon.
2. Enter username and password if necessary and click **Connect**.  
Wait for the connection to be completed, indicated by a **Dial-up Networking** icon in the task bar tray.

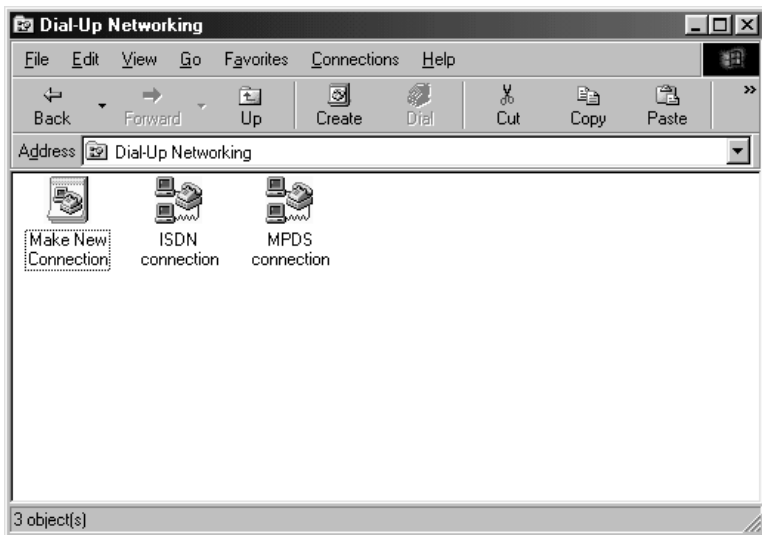

Disconnect by right-clicking the tray icon and choosing **Disconnect**.

## Setting up ISDN

### *ISDN hardware connection*

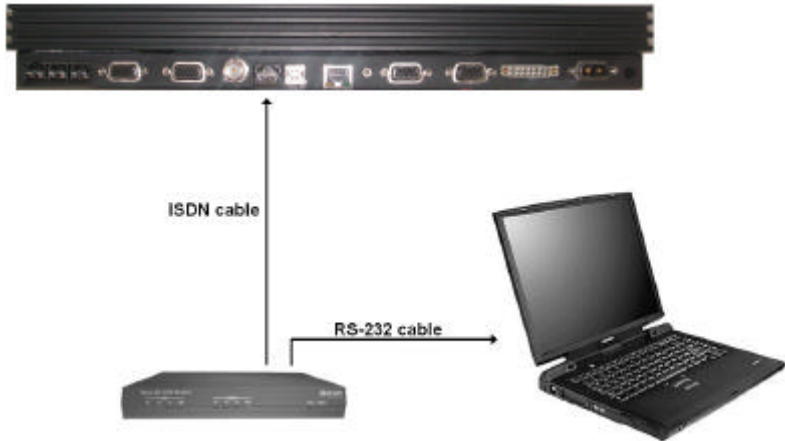

The ISDN connection is made by connecting an ISDN modem to the computer via an RS-232 cable. The modem is connected to the Fleet system via an ISDN cable. The appropriate modem driver must be installed on the computer. See the manufacturers installations guide for details on how to do this.

The terminal can be connected to ISDN equipment via an ISDN cable. The equipment can be video phones, audio recorders, STE phones, modems, etc.

The correct routing has to be configured via the handset. See *Routing* on page 66 on how to route the ISDN interface.

The setup procedure below shows how to setup an Internet connection via ISDN.

Connect an ISDN modem to the ISDN interface. Connect the modem to a PC via a standard RS-232 cable or a USB cable if the modem supports this interface.

### *Setting up your PC*

Follow the modem manufacturers installation instructions for the appropriate operating system. For this example a Lasat Unique 1280i ISDN modem was installed under Windows 98.

### Step 1: Install a modem

1. From the Control Panel select Modems and add a modem.
2. Let Windows detect the modem automatically.

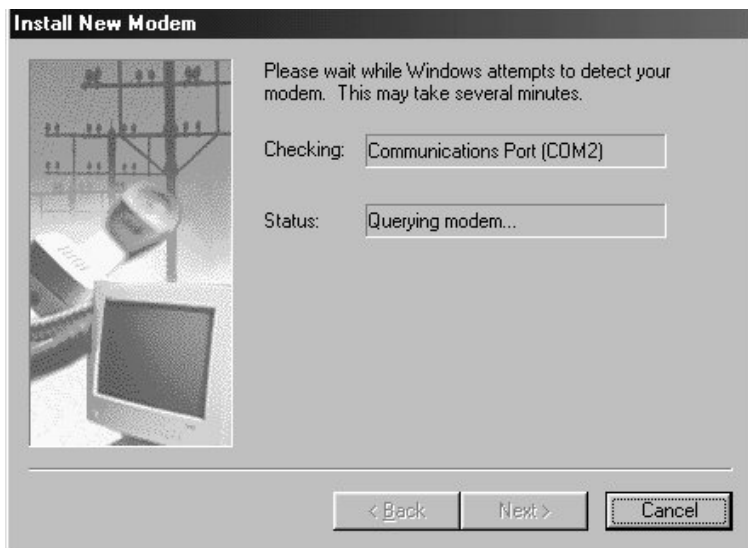



### Step 2: Create a Dial-up connection

1. Open **Dial-up Networking** from **My computer**. Click **Make new connection**.
2. Select the Lasat modem defined during step 1 as the dial up device.

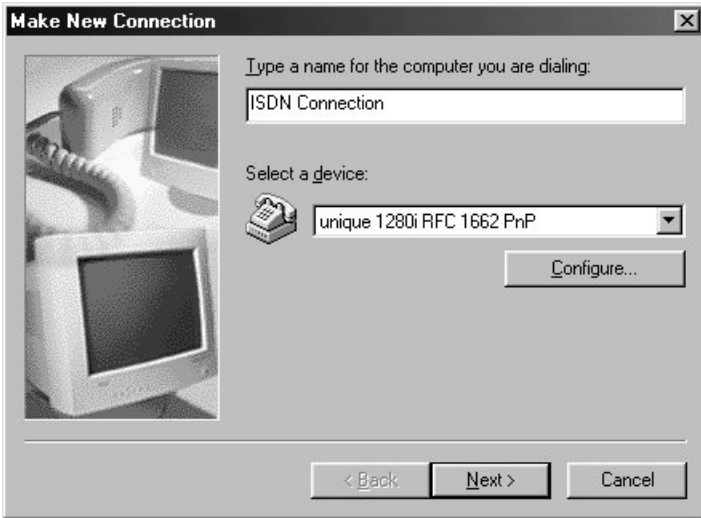

3. Click **Next**.

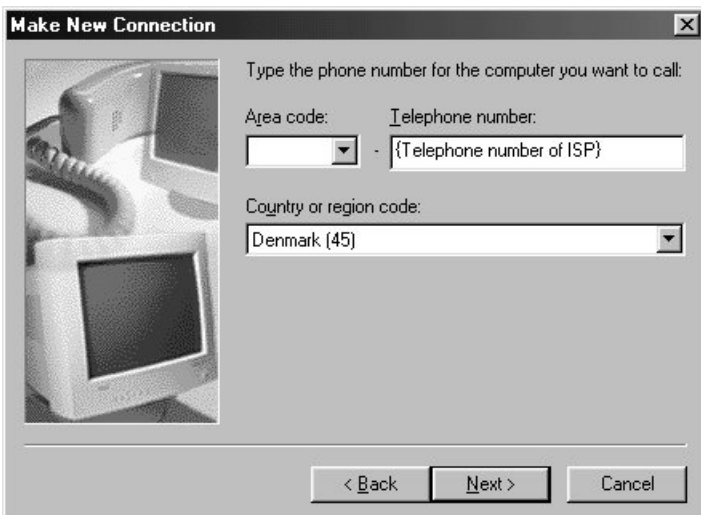

4. Enter the telephone number to the Internet Service Provider. Remember country code and area code if necessary and click **Next >**.
5. Give the connection a recognizable name e.g. ISDN connection, and click **Next >**.

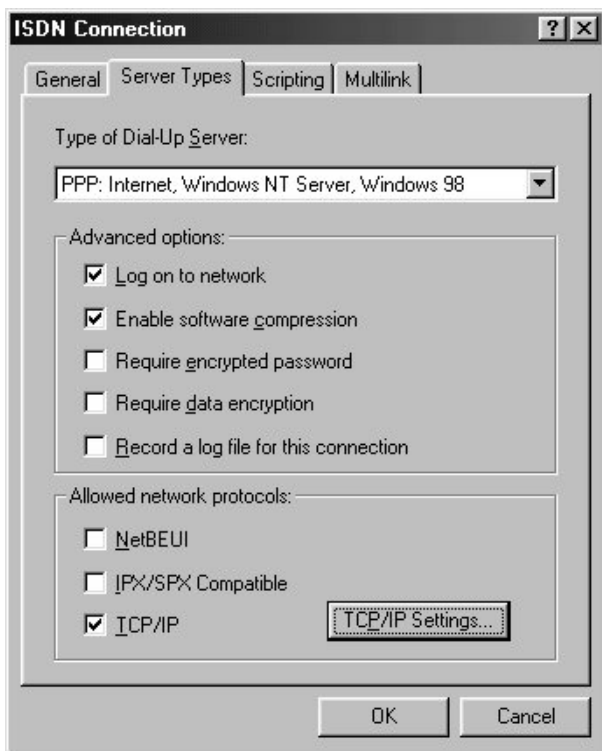

Include TCP/IP as allowed network protocol and click **TCP/IP settings**.

6. Use TCP/IP settings (Server assigned IP address, Server assigned name server addresses etc.) as recommended by the ISP.

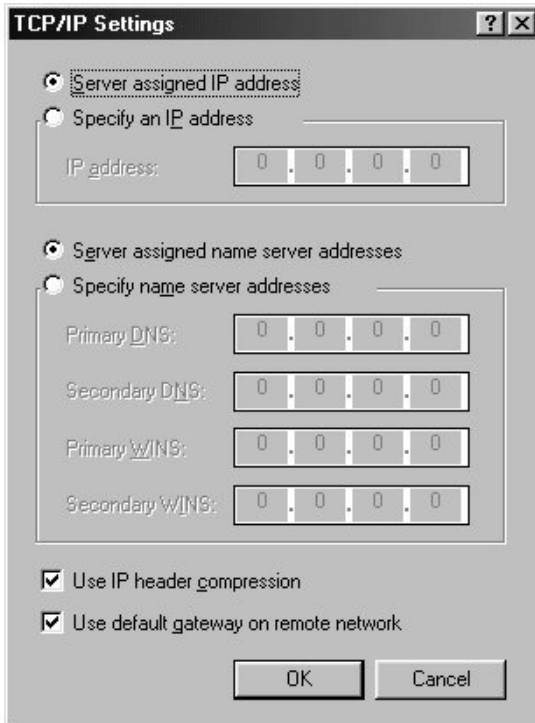

After this, a connection can be started automatically by an application like Internet Explorer or Outlook Express. The connection can also be established manually. In Windows, open **Dial-Up networking** and double click the appropriate icon. Enter username and password if necessary. Click **Connect**. Wait for the connection to be completed, indicated by a **Dial-up Networking** icon in the task bar tray.

The connection can be disconnected by right clicking the tray icon and choosing **Disconnect**.

## Setting up 64 kbps UDI using USB

### Introduction



The USB interface can be used for the 64 kbps UDI service from a connected PC with a Fleet55/77 driver properly installed.

### Setting up your PC

This setup procedure is intended for PCs running an MS-Windows operating system and the screen shots are from a Windows 2000 installation. This section is divided into two steps: Driver installation and setup of a Dial-up connection.

#### Prerequisites

Before connecting the Fleet55/77, insert the Fleet CD-ROM and copy the directory named **drivers** to your PC, i.e. to **C:\Program Files\Thrane\**.



### Step 1: Install the USB Driver

1. Connect the Fleet transceiver to you PC using a standard USB cable. A **Found New Hardware** window will appear shortly after.

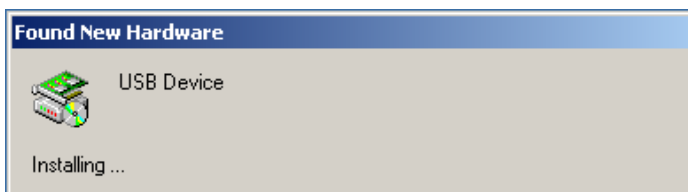

2. After a moment the **Welcome to the Found New Hardware Wizard** window appears.

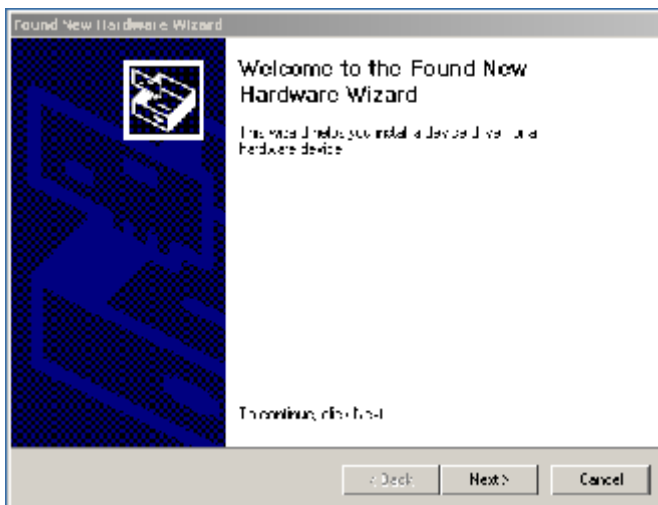

3. Click **Next >** and the **Install Hardware Device Drivers** window appears.



Select **Display a list** and click **Next >**.

4. Click **Next >** and the **Hardware Type** window appears. Select **Modems** and click **Next >**.

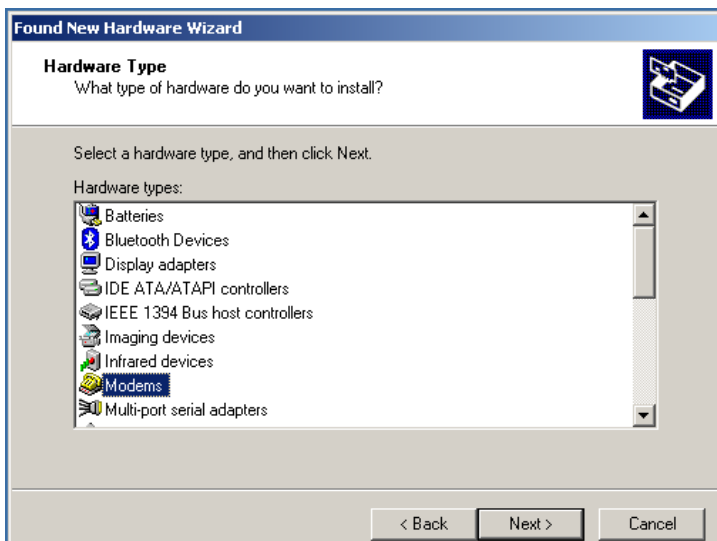

5. The **Install New Modem** window appears. Click **Have Disk..**

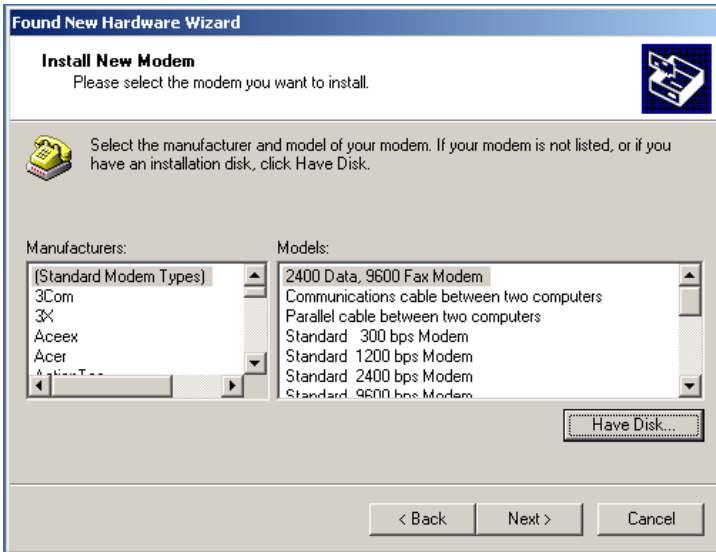

6. Click **Browse** and choose the directory where you placed the drivers. Then click **OK**.

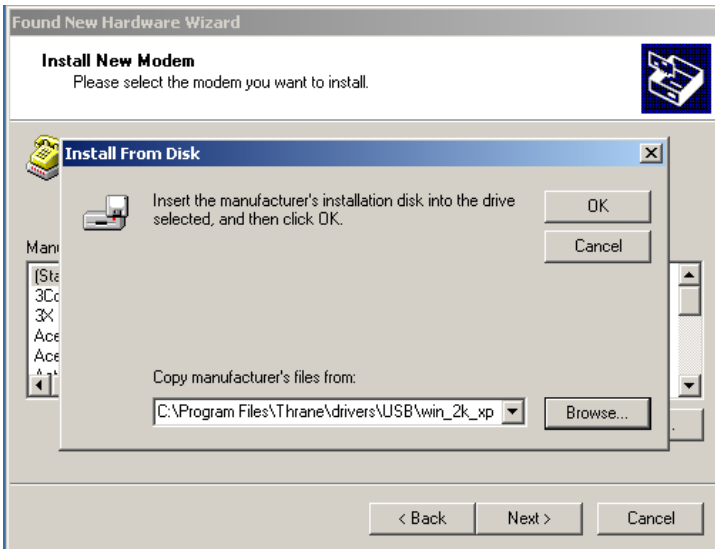

7. When the next screen appears click **Next >**.

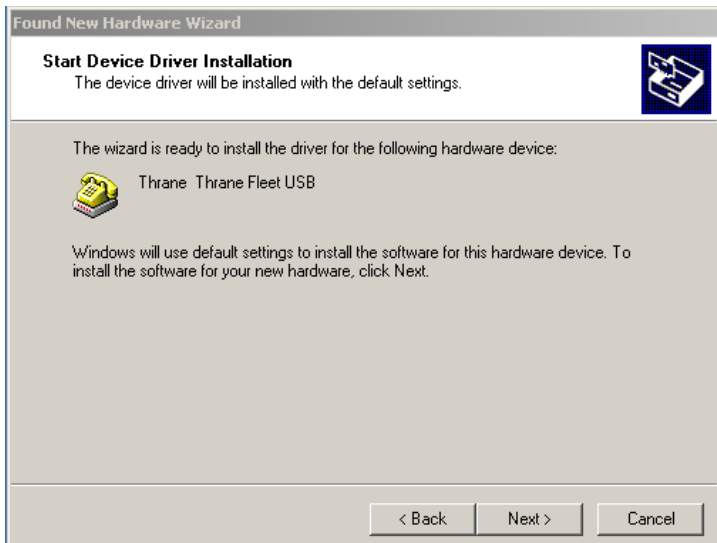

8. Click **Next >**.

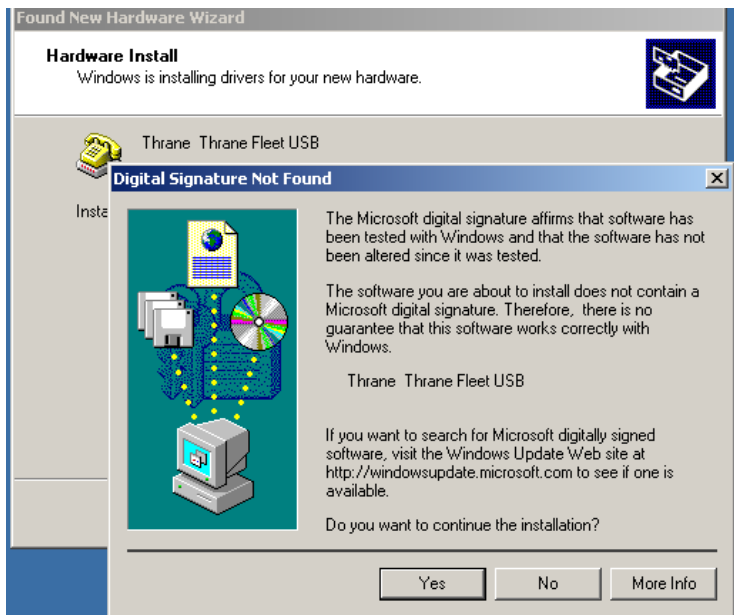

9. Click **Yes**.

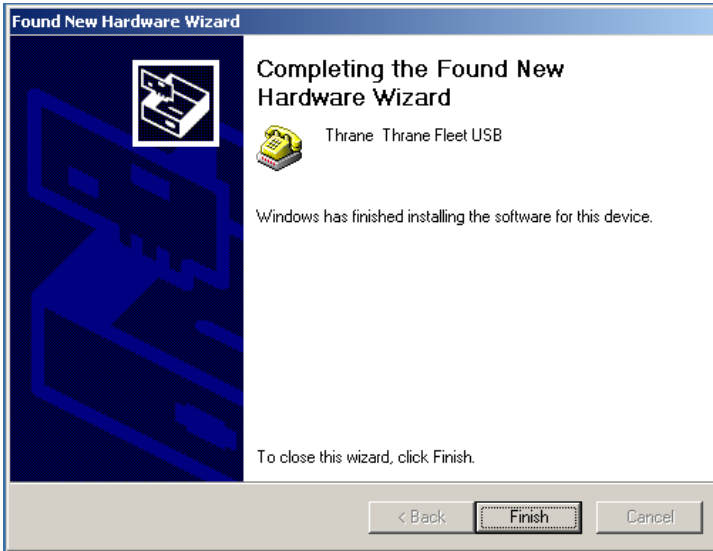

10. Click **Finish** to complete the driver installation.

11. Now open the Control Panel and double click on **Phone and Modem Options**.

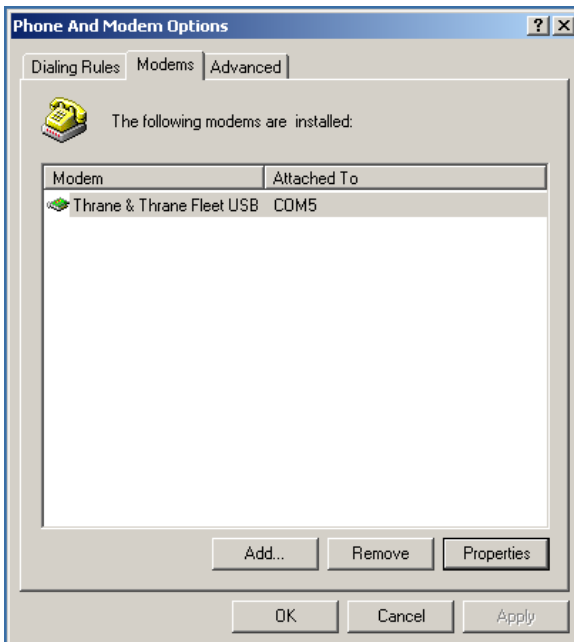
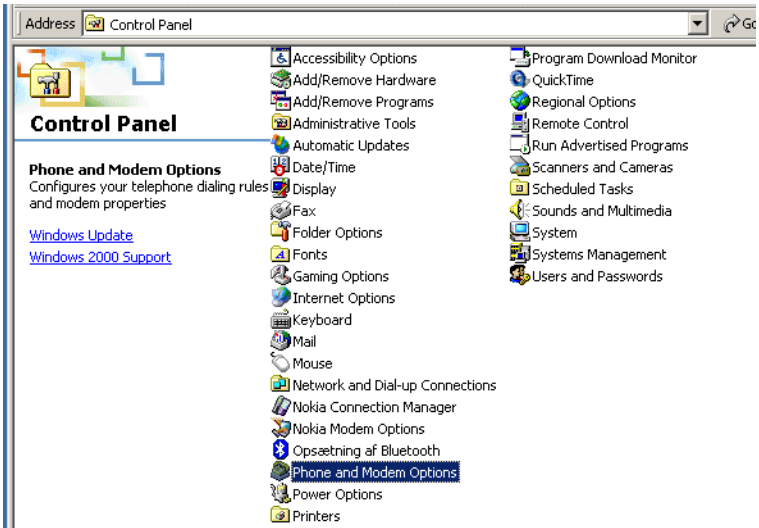

12. Select the **Modem** tab and choose **Properties**.
13. Select the **Advanced** tab and enter the initialization string **AT+WS45=6** and press **OK**.

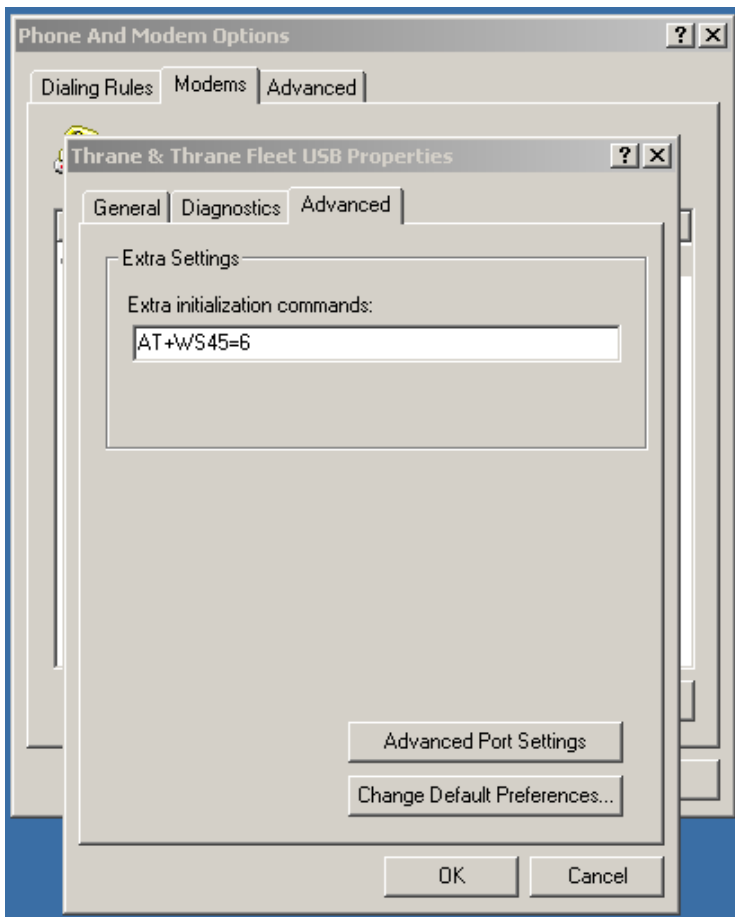

## Step 2: Create a Dial-up connection

1. Make a new connection by selecting **Start > Settings > Network and Dial-up Connections > Make New Connection**.

A **Welcome to the Network Connecting Wizard** window appears.



2. Click **Next >**.

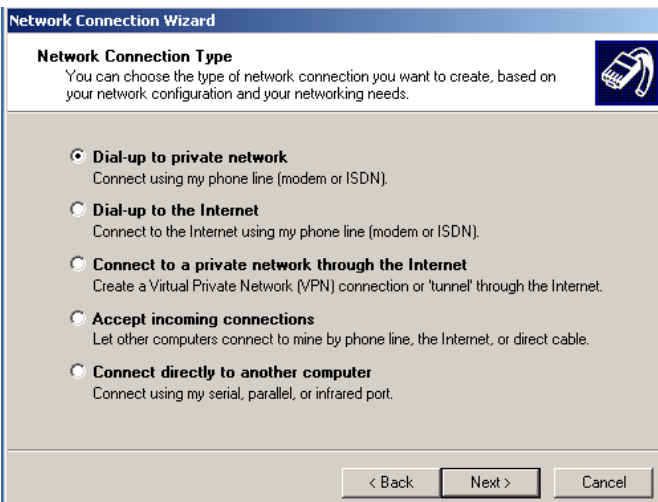



3. Select **Dial-up to private network** and click **Next >**.

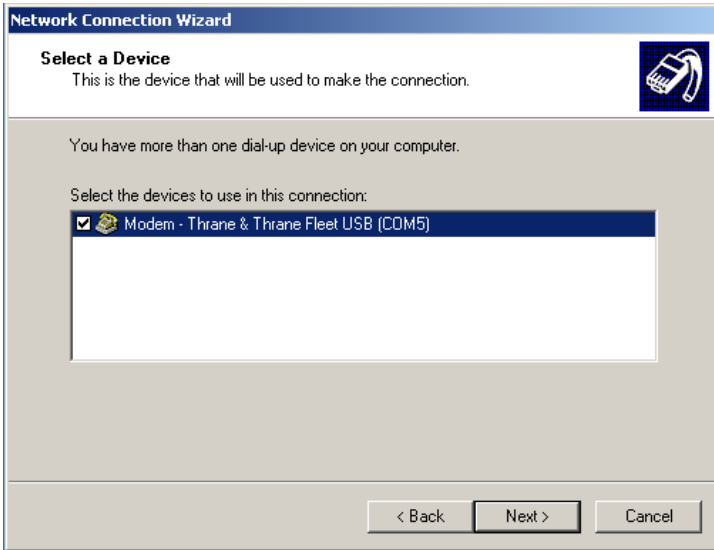

4. Select **Thrane & Thrane Fleet USB** and click **Next >**.

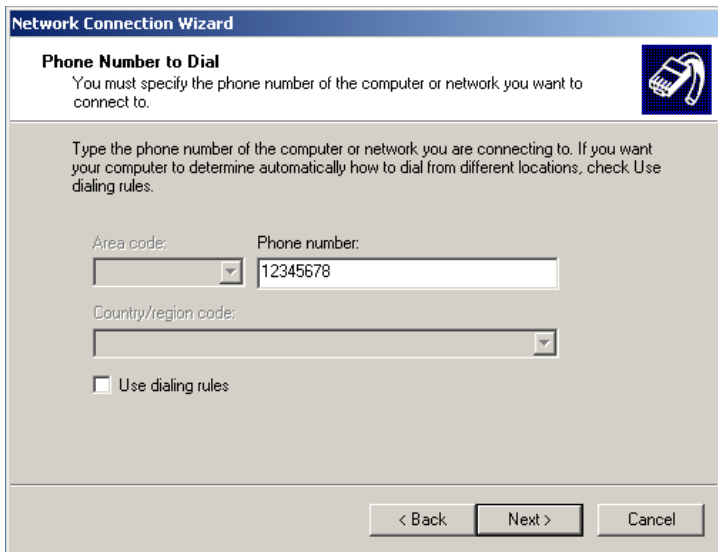

5. Enter the destination phone number (i.e. Internet Service Provider) and click **Next >**.

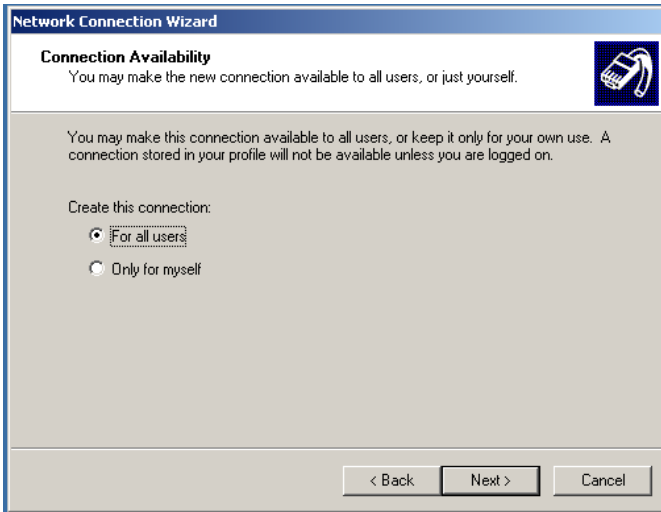

6. Select **For all users** or **Only for myself** and click **Next >**.



7. Enter a name for the dial-up connection and click **Finish**.  
The system will now connect using USB.

## Setup using Ethernet/PPPoE

### Overview

This chapter describes the set-up and operation of data connections via Ethernet and PPPoE using various PPPoE clients.

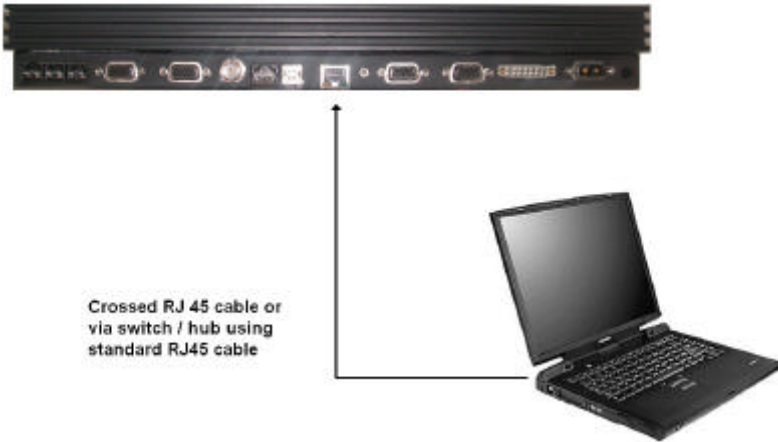

### Windows XP with built-in PPPoE client

#### *Prerequisites*

The PC must have an Ethernet adapter and Windows XP installed and both must be operational. There must be a network connection between the PC and the Fleet system. As an example the transceiver can be connected to the computer through a switch or hub or directly using a crossover cable.

## Setting up the connection

1. From the **Start** menu select **Settings**, then **Network Connections** and then **Create New Connection**.  
This brings up the **New Connection Wizard**.
2. Click **Next >**.
3. Select **Connect to the Internet** and click **Next >**.
4. Select **Setup my connection manually** and click **Next >**.
5. Select **Connect using broadband connection requiring user name and password** and click **Next >**.
6. Type a name for the connection, e.g. "MPDS via PPPoE" and click **Next >**.
7. Select **Anyone** and click **Next >**.
8. Type a random user name and password and click **Next >**.
9. Select the shortcut on desktop option.
10. Click **Finish**.
11. Now click the new shortcut on the desktop named **MPDS via PPPoE**.  
The SAILOR F77 system should now make the connection.

**Note**

Because of the relatively long set-up time for a data connection, the PPPoE connection may sometimes time out.

## Windows 2000 WinPoET PPPoE client

### PPPoE Clients

The data connection via Ethernet and PPPoE can be established using various PPPoE clients.

The PPPoE client WinPoet can be obtained through your local Thrane & Thrane distributor and works for both Macintosh and PC.

### Prerequisites

The computer must have a working Ethernet adapter. Connect the transceiver to the computer through a switch or hub or connect directly using a crossover cable.

### Installation

The WinPoET program will most likely be installed from a CD.

1. Double click the **Setup.exe** icon to begin installation.

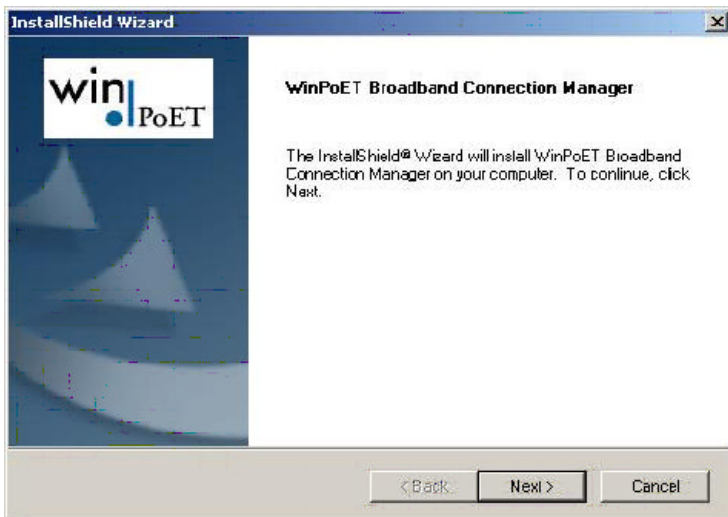

2. Click **Next >** and **Yes** to accept the license agreement.



3. Choose the installation directory and click **Next >** to install. The program is now installed.

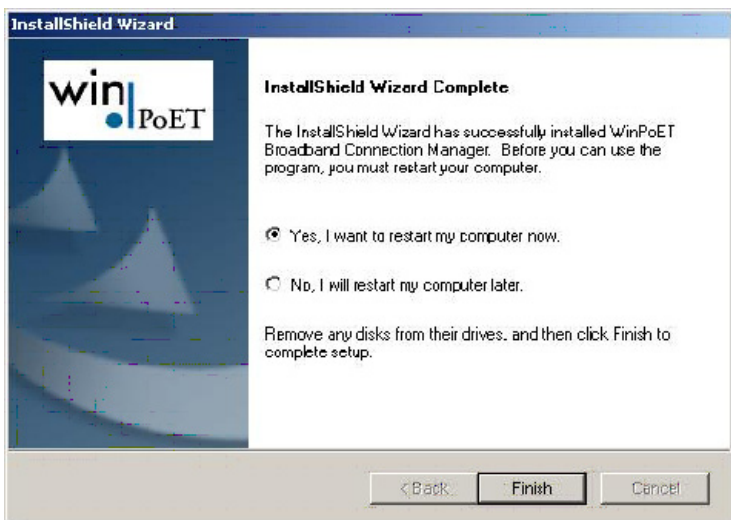

4. When installation is done, click **Finish** to restart the computer.

5. Find the shortcut on the desktop called **WinPoET Broadband Connection Manager** and double-click it.

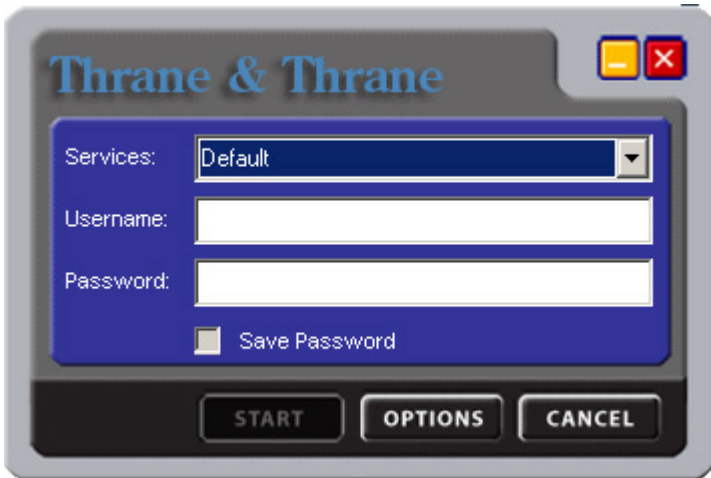

6. Enter a random user name and password and click **START**.

The status field tells you how far you have reached in the connection process. After a successful authentication the status of the terminal will be **Connected**. The user is now capable of using the Internet as with any traditional connection.

# Troubleshooting

## List of Error messages

### Inmarsat defined alarms

This section describes possible Cause Codes that may be displayed in the handset of the SAILOR Fleet77 or SAILOR Fleet55.

Please note that all Cause Codes are also described in the Inmarsat SDM (System Definition Manual).

See also Inmarsat-M SDM Module 1 paragraphs 4.6.13 and 4.6.14.

The following four fields are used in conjunction in order to signal the cause indication result:

Cause code 1097:

A = Coding Standard (1 bit)	e.g. 1
B = Cause Location (4 bit)	0
C = Cause Class (4 bit)	9
D = Cause Value (4 bit)	7



The list below shows the Cause codes that may be displayed in the handset.

Cause code	Description	Event
1001	Normal	MES is clearing the call as instructed by the relevant MES terminal equipment (i.e., normal clearing due to MES terminal "on-hook" etc.)
1011	Called party is busy.	MES is rejecting the call because the specified MES terminal number is currently busy, and MES has not been authorized to divert calls which are addressed to that number.
1012	Called party is busy	MES is clearing the fixed-originated call because subsequent to the acceptance of the call and the signaling of the identity of the mobile terminal to which the call will actually be routed, that terminal has become busy and hence cannot be called.
1021	No User responded	MES is clearing the call because appropriate "off-hook" signaling has not been received from the addressed MES terminal (including any authorized diversions) within the allowed time limit.
1081	Identified channel does not exist	MES is rejecting the call because the specified MES terminal number has not been installed, and MES has not been authorized to divert calls which are addressed to that number.

Cause code	Description	Event
1091	Destination out of order	MES is rejecting the call because the specified MES terminal number is currently out-of-service, and MES has not been authorized to divert calls which are addressed to that number.
1092	Destination out of order	MES is clearing the fixed-originated call because subsequent to the acceptance of the call and the signaling of the identity of the mobile terminal to which the call will actually be routed, that terminal has become out-of-service and hence cannot be called.
1141		Call cleared, MES initiated preemption
1142		Call cleared, MES initiated preemption
1143	Preemption	MES is prematurely clearing the fixed-originated call which is in the process of being established, because the MES user has initiated a call from a terminal which is authorized to automatically preempt an existing fixed-originated call.
1144	Reserved	

Cause code	Description	Event
1145	Preemption	MES is prematurely clearing the mobile-originated call which is in the process of being established, because the MES user has initiated a call from a terminal which is authorized to automatically preempt an existing mobile-originated call.
1146	Normal	MES is prematurely clearing the mobile-originated call which is in the process of being established because the MES user has abandoned the call (by placing the originating terminal "on-hook").
11A0		LES is clearing the call because the credit card being used is not valid (at this LES) for calls to the country indicated in the "service address" information received from the MES
11D1	Inconsistency in designated outgoing access information and subscriber class.	LES is rejecting the call because the "Service Nature" and/or "Service Type" and/or "Channel parameter" information received from the MES is invalid (e.g., not currently defined in the SDM, mutually contradictory, or not applicable to a MES-originated call).
11D2	Invalid number format (address incomplete)	LES is clearing the call because the "service address" information received from the MES is invalid (i.e., less than 2 digits)

Cause code	Description	Event
11D3	Protocol error, unspecified	LES is clearing the call because the "service address" information received from the MES is a 2-digit address which is either undefined or which is currently unavailable at this LES.
11D4	Protocol error. Unspecified	LES is clearing the call because "credit card data" information received from the MES is invalid. [This does not imply that the credit card itself is invalid].
11D5	Protocol error, unspecified	LES is clearing the call because the "service address" information received from the MES contains a country code which is regarded (by this LES) as invalid.
11D6	Inconsistency in designated outgoing access information and subscriber class.	LES is clearing the call because the "PID" information received from the MES in the "scrambling vector" message (type 8DH) is not consistent with the PID information in the Fixed/MES-Originated (PID) and PID/MES Registration Tables at the LES as it relates to this call.
11E0		LES is clearing the call because the credit card PIN received from the MES is not considered (at this LES) to be valid.

Cause code	Description	Event
11E1		LES is clearing the call because it has been determined that an excessive number of consecutive call attempts with invalid credit card PINs have been made.
1201	Reserved	
1261	Reserved	
1262		Call cleared, MES time-out (Distress Test exceeded 120 s)
1281	Channel type not implemented.	MES is rejecting the call because the MES is not equipped to provide the specified service.
1291	Requested circuit/channel not available.	MES is rejecting the call because although it is equipped to provide the specified service, it is not currently able to do so.
12B1	Interworking. Unspecified.	MES is rejecting or clearing the call for a reason which is not covered by any of the currently defined "Cause" events.
12C1		Call failed, MES time-out (no scrambling vector ack).

Cause code	Description	Event
12C2	Protocol error. Unspecified.	MES is clearing the call because a "credit card valid" message (type A7H) has not been received by the MES within the allowed time limit.
12C3	No User responded.	MES is clearing the call because a "LES Connect" message (type 8CH) has not been received by the MES within the allowed time limit.
12C4	Protocol error. Unspecified.	MES is clearing the call because the "authentication query" ISU message (type B4H) and/or the "authentication query" SSU message (type B5H) have not been received by the MES within the allowed time limit.
12C5	Protocol error. Unspecified.	MES is clearing the call because (an) expected supplementary services SU(s) has(have) not been received by the MES within the allowed time limit.
12C6	Protocol error. Unspecified.	MES is clearing the call because the "supplementary services interrogation" ISU (type B2H), and/or "subscriber digits" SSU (type ADH) messages have not been received by the MES within the allowed time limit.

Cause code	Description	Event
12C7	Protocol error. Unspecified.	MES is clearing the call because a "SCPC channel release" SU (type 8AH) has not been received by the MES, in response to the transmission of a "notification acknowledge" message (type BAH) during the supplementary services call diversion information retrieval process, within the allowed time limit.
12C9	Protocol error, unspecified.	MES is clearing the call in mobile-originated call setup, because a subsequent 56/64 kbps call request was not received from the mobile-user TE / calling party following establishment of a previous 56/64 kbps call multiplexed onto a carrier.
12CA	Protocol error, unspecified.	MES is clearing the call in mobile-originated call setup, because LES connect messages have not been received from the LES following a request (through Channel Alert messages) to establish a subsequent 56/64 kbps call multiplexed onto a single carrier.
12D1	Protocol error, unspecified.	LES is rejecting the call because the "spot-beam ID" information received from the MES is invalid (i.e., ID is not allocated on satellite in use).

Cause code	Description	Event
12D2	Protocol error. Unspecified.	LES is clearing the call because the "Scrambling Vector" information received from the MES is invalid (ie,0000H, 6959H or 7FFFH).
1351		MES is clearing the call because the MES currently has insufficient free memory in which to store the short message.
1361	Temporary failure.	MES is clearing the call because the Above-decks equipment is about to "cable unwrap".
1362	Recovery on timer expiry.	MES is clearing the call because a long-term interruption in reception has occurred (the definition of a "long-term interruption" depends upon the service type, see Section B).
1363	Preemption.	A Secondary Functional Center of a Multi-channel MES is clearing the call because the Primary Functional center has commanded the Above-decks equipment to repoint to a different Ocean Region.
1392		Call cleared, spot beam transition.
1451	No circuit/channel available.	LES is rejecting the call because an appropriate terrestrial circuit is not currently available at this specific LES.



Cause code	Description	Event
1452	No circuit/channel available	LES is rejecting the call because an appropriate channel unit and associated terrestrial circuit are not currently available at this LES. [This "cause" is only utilized when there is a permanent "one-to-one" connection between appropriate channel units and their terrestrial circuits].
14C1		LES is clearing the call in mobile-originated call setup because ISDN Channel Alert messages (used to establish a subsequent 56/64 kbps call multiplexed onto a single carrier) have not been received from the MES following transmission of MES connect messages.
1541		Call cleared, preempted at LES.
1551		LES is rejecting the call because an appropriate satellite channel is not currently available at this specific LES.
1552	Reserved	
1581	Requested circuit/channel not available	LES is rejecting the call because the requested service is not provided by this specific LES.
1591	Temporary failure	LES is rejecting the call because the requested service is temporarily not available at this specific LES.

Cause code	Description	Event
1592		LES is clearing the call because the specified credit card type is not currently supported by this specific LES.
15A1	Bearer capability not authorized	LES is rejecting the call because the specified MES is not authorized for any service at this specific LES.
15A2	Bearer capability not authorized	LES is rejecting the call because the specified MES is not authorized to use specific requested service via this specific LES.
15A3		LES is clearing the call because the "credit card data" information received from the MES has been rejected by the credit card authorization process.
15A4		LES is clearing the call because the data received from the MES in the "authentication reply" message (type B6H) has been declared "invalid" by the LES authentication process.
15A5	Bearer capability not authorized	LES is rejecting the call because the specified PID is not authorized for any service at this specific LES.
15A6	Bearer capability not authorized	LES is rejecting the call because the specified PID is not authorized to use specific requested service via this specific LES.

Cause code	Description	Event
15B1	Interworking. Unspecified.	LES is rejecting or clearing the call for a reason which is not covered by any of the currently defined "Cause" events.
15C1	Protocol error, unspecified.	LES is rejecting the call because an appropriate "Channel Assignment" message has not been received by the LES within the allowed time limit.
15C2	Protocol error. Unspecified.	LES is clearing the call because the "service address" information has not been received by the LES within the allowed time limit.
15C3	Protocol error, unspecified.	LES is clearing the call because a "Scrambling Vector" message (type 8DH) has not been received by the LES within the allowed time limit.
15C4	Protocol error. Unspecified.	LES is clearing the call because neither the "service address" information nor a "Scrambling Vector" message (type 8DH) has been received by the LES within the allowed time limit.
15C5	Protocol error. Unspecified.	LES is clearing the call because the complete "credit card data" information has not been received by the LES within the allowed time limit.
15C6	Reserved	Call failed, LES time-out (return carrier identifier).

Cause code	Description	Event
15C7	No answer from user (user alerted).	LES is clearing the call because a "MES Connect" message (type 99H) has not been received by the LES within the allowed time limit.
15C8	Reserved	
15C9		LES is clearing the call because a "authentication reply" message (type B6H) has not been received by the LES within the allowed time limit.
15CA		LES is clearing the call because a "notification acknowledge" message (type BAH) has not been received by the LES within the allowed time limit.
15CB		LES is clearing the call because the request sequence number contained in the received "notification acknowledge" message (type BAH) is not valid (i.e. either not '0' or not the next value in the sequence).
15CF		LES is clearing the call because MES connect messages have not been received from the MES following transmission of Channel Alert messages or LES connect messages used to establish a subsequent 56/64 kbps call multiplexed onto a single carrier.

Cause code	Description	Event
15D1	Message with unrecognized parameter, discarded.	LES is rejecting the call because the "Channel Assignment" message received from the NCS contains inappropriate or conflicting information.
15D2	CES → NCS Signaling only.	LES is clearing this MES ID and channel number in the busy lists at LES and NCS because a new call to/from this MES is being set-up (and thus any previous call to/from this MES must have cleared).
15E1	Preemption - circuit reserved for reuse.	LES is attempting to clear an MES which has sent an SCPC channel release message but is found still to be transmitting 5.12 s later.
1651	No circuit/channel available.	LES is rejecting the call because an appropriate channel unit is not currently available at this specific LES.
1661	Recovery on timer expiry.	LES is clearing the call because of an interruption in reception of the MES carrier exceeding the allowed time limit.
16C1	Reserved	
16C2	Recovery on timer expiry.	LES is clearing the call because an appropriate SCPC MES carrier has not been received by the LES (at the commencement of the call) within the allowed time limit.

Cause code	Description	Event
1790		LES is clearing the call because of a malfunction in the credit card validity checking database or in the communications links thereto.
1791		LES is clearing the call because of a malfunction in the authentication checking database or in the communications links thereto.
1811	Called party is busy	NCS is rejecting the call because the specified MES ID is in the "MES busy" list at the NCS.
1841		Call cleared, NCS initiated preemption for incoming Pri 1 call.
1842		Call cleared, NCS initiated preemption for incoming Pri 2 call.
1843		Call cleared, NCS initiated preemption for incoming Pri 3 call.
1844		Call cleared, NCS initiated channel preemption.
1851	No circuit/channel available	NCS is rejecting the call because an appropriate SCPC channel is not currently available.
1855		Call rejected, preemption failed, no channel available.

Cause code	Description	Event
1856		Call rejected, spot beam selection failed.
18A1	Bearer capability not authorized.	NCS is rejecting the call because the specified MES ID was not found in the "Forward and Return MES ID" cross-reference table.
18A3		
18B1	Interworking, unspecified.	NCS is rejecting or clearing the call for a reason which is not covered by any of the currently defined "Cause" events.
18C1	Subscriber absent.	NCS is rejecting the call because no message was received from the specified MES (in reaction to a Call Announcement message) within the allowed time limit.
18E1	Called Party is busy.	NCS is rejecting the call because the specified MES ID is in the "MES busy" list at the NCS, and is listed as being busy with a call through the same LES as that now requesting a "call announcement" addressed to that MES.
1C61		

Cause code	Description	Event
1F01	Normal	LES is clearing the call because of the receipt of "on-hook" signalling from the relevant terrestrial circuit (i.e., normal clearing).
1F11	Called Party is busy.	LES is clearing the call because the terrestrial called party is engaged (busy).
1F21	No User responded.	LES is clearing the call because appropriate "off-hook" signalling from the terrestrial called party has not been received by the LES within the allowed time limit.
1F31		LES is clearing the call in fixed-originated call setup, because a subsequent 56/64 kbps call request was not received from the terrestrial-user TE / calling party following establishment of a previous 56/64 kbps call multiplexed onto a single carrier.
1F61	Destination out of order.	LES is clearing the call because of the detection of a failure in the relevant terrestrial circuit.
1F62	Normal	The LES is clearing the call because the terrestrial calling party or the terrestrial network has cleared the call before the "MES connect" message has been received by the LES.



## Non-Inmarsat Alarms

The table below shows the non-Inmarsat alarms.

Alarm type	Alarm messages
CPU Alarms	Tx-Level Not Ok
	1. LO Lock Not Ok
	2. LO Lock Not Ok
	3. LO Lock Not Ok
	Vtune Alarm
	Unanswered distress call received
	Unanswered urgency priority call received
	Distress LES not selected in all ocean regions
	One or more of the selected distress LESs are not operational
	At least one selected distress LES has no distress capability
	Invalid position information received from GPS
	MSR Corrupt
	MIR Corrupt
	MIDR Corrupt
	NAR Corrupt
	NSR Corrupt
	SVR Corrupt

Antenna Alarms	Antenna (FEU), Wrong Type, Check Conf.
	Antenna (FEU) Link Down, Check Cable
	FEU Reset, Powered Down
	FEU Reset, Sleep Mode
	FEU Error, To Follow
	FEU Status, heat alarm
	FEU Status, burst alarm
	FEU Status, power alarm
	FEU Status, reset
	FEU Version Mismatch, Try Upload
	ACU Comm, Failure
	ACU Reset, Powered Down
	ACU Reset, Sleep Mode
	ACU Error, To Follow
	Kernel Error, Float pnt
	Kernel Error, 80Hz tsk overrun
	Kernel Error, RX2 UART tsk overrun
	Kernel Error, SCI tsk overrun
	Memory Error, Cont SW CRC
	Memory Error, ACU Cnf Data

	Memory Error, ACU Cal CRC
	Memory Error, FLASH mem
	Memory Error, ACU SRAM
	Memory Error, ACU EEPROM
	Memory Error, FPGA Init
	Memory Error, FPGA SW CRC
	Motor Error, Azm Drive
	Motor Error, Elv Drive
	Motor Error, Azm Winding
	Motor Error, Elv Winding
	Motor Error, BSM Winding
	Motor Error, FPGA cmdtmo
	Pos feedback, BSM Zero Ref
	Pos feedback, Azm Encoder
	Pos feedback, Elv Encoder
	Pos feedback, Elv Positive End Stop
	Pos feedback, Negative End Stop
	Pos feedback, Azm Zero Ref
	SU Error, Cal Data CRC
	SU Error, Initialize
	SU Error, Comm

	SU Error, protocol
	SU Error, Sys Info CRC
	Sensor Err, Roll Incl
	Sensor Err, Pitch Incl
	Sensor Err, Roll Rate
	Sensor Err, Pitch Rate
	Sensor Err, Yaw Rate
	Ctrl Logic, ACU Matrix
	Ctrl Logic, RX2 Comm
	Ctrl Logic, RX2 AutoTune
	Ctrl Logic, ACU resett.
	Ctrl Logic, RX2 tunetmo
	Ctrl Logic, RX2 dither
	Ctrl Logic, RX2 PLL
	RX2 Error1, EEPROM
	RX2 Error1, Temperature
	RX2 Error1, No Signal
	RX2 Error1, Channel Out Of Range
	RX2 Error1, Param Out Of Range
	RX2 Error1, AutoTune
	RX2 Error2, RX2 RSSI lo

	RX2 Error2, RX2 RSSI hi
	UNKNOWN ERR pos:
Handset Alarms	Handset COMError <sup>a</sup>

- a. This error means that the communication between handset and BDU has stopped for some reason. It is not necessarily an error caused by the handset, but it may be caused by errors in e.g. BDU, ADU, and/or connection cables.

## Menu Tree

### Main menu

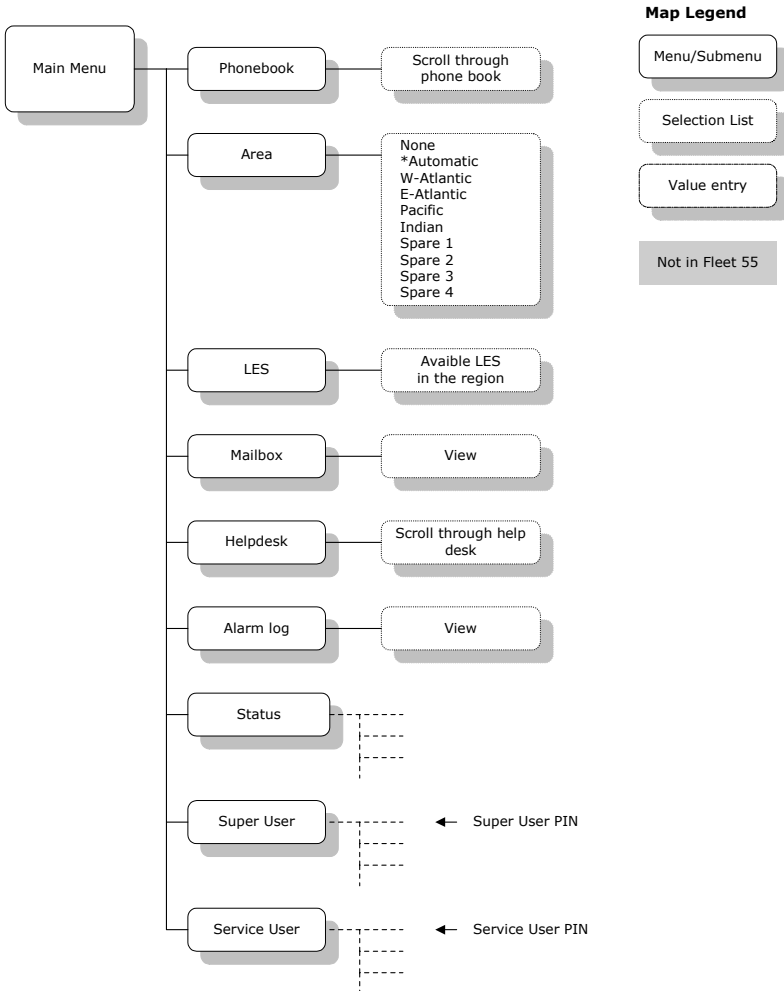

## Status menu

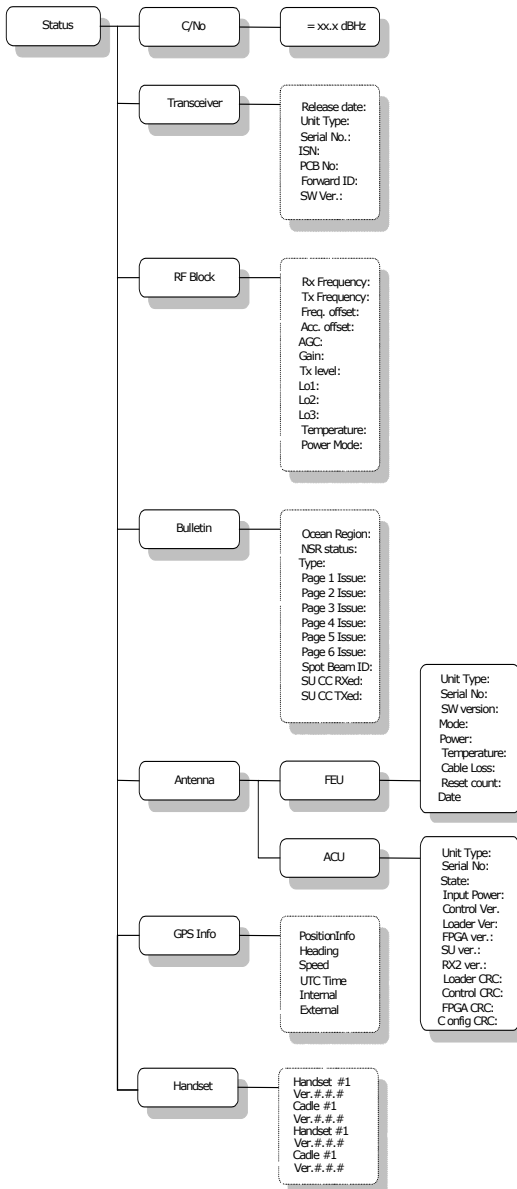

# Super User menu

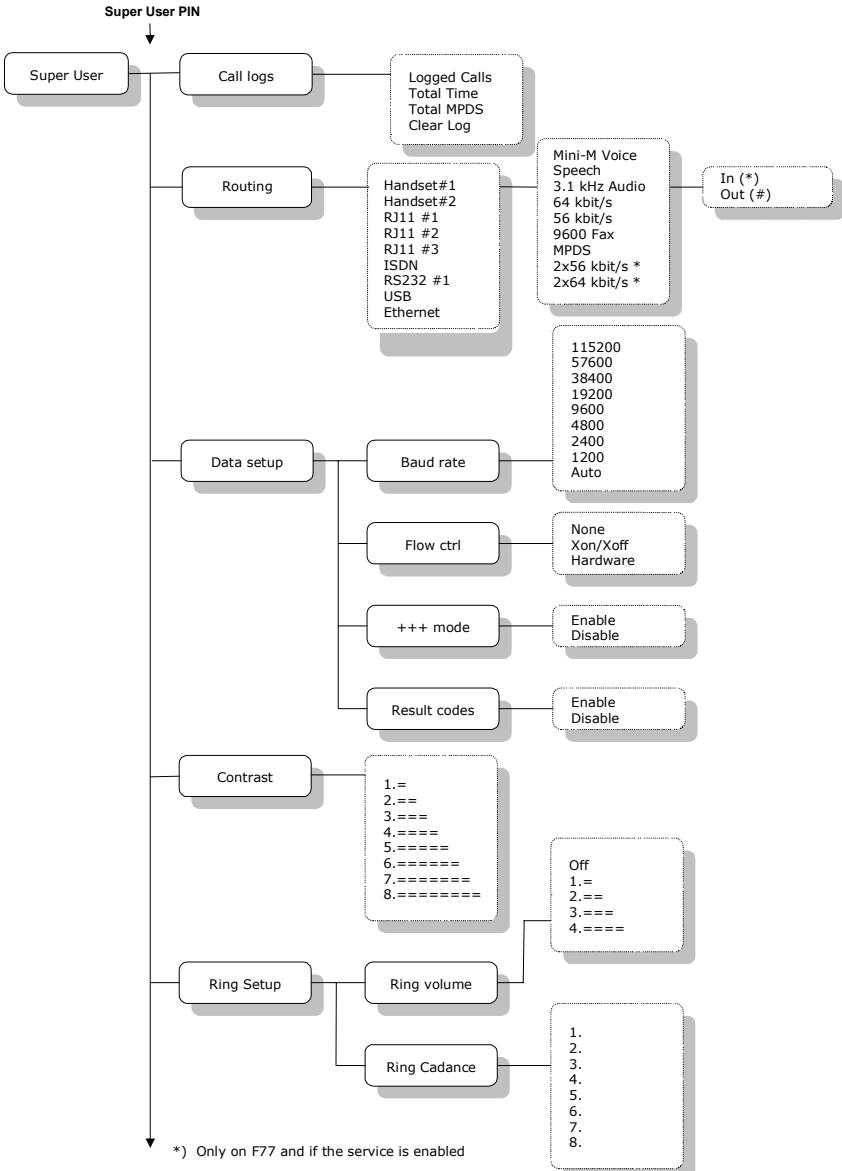



## Super User menu, continued

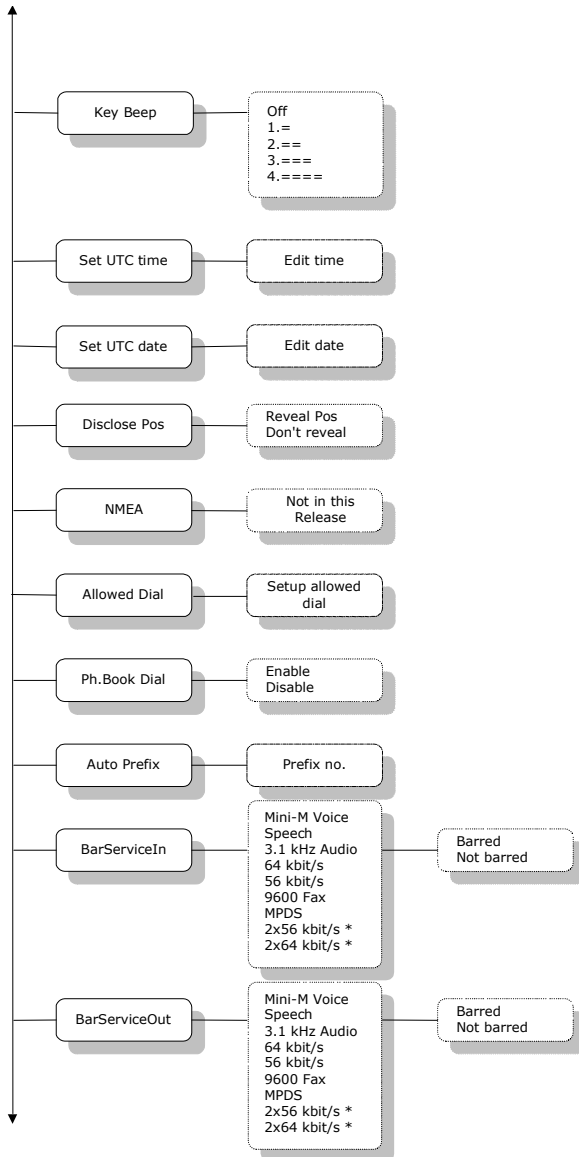

\*) Only on F77 and if the service is enabled

## Super User menu, continued

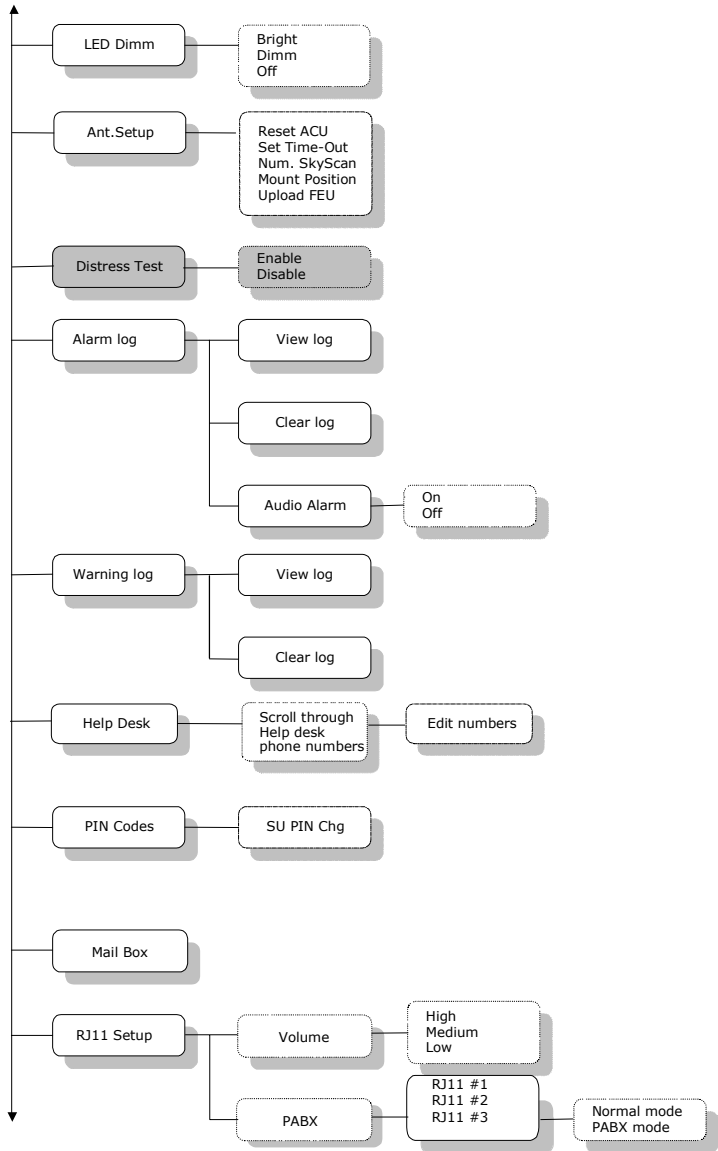

## Super User menu, continued

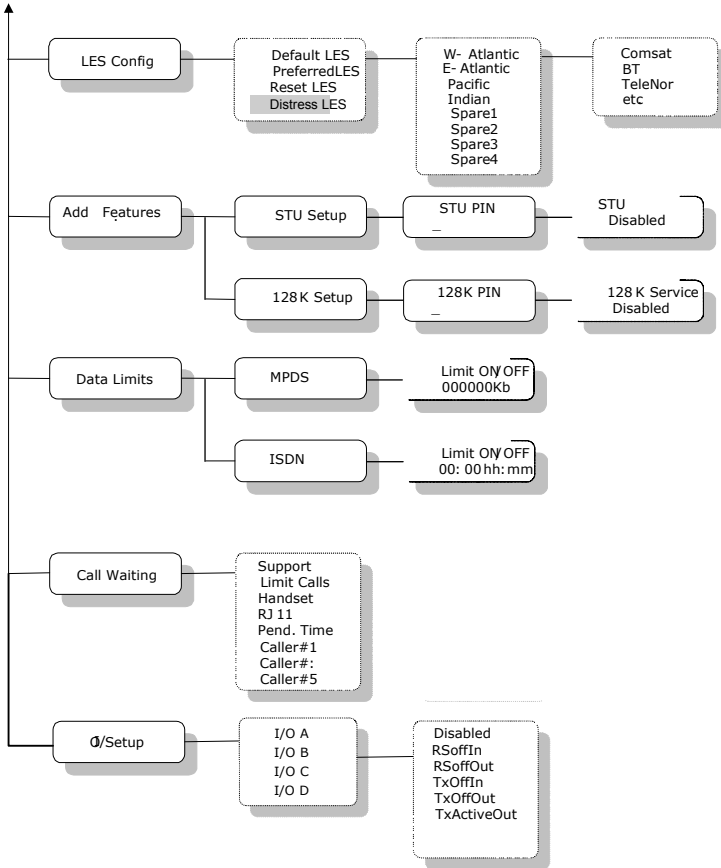

# Service User menu

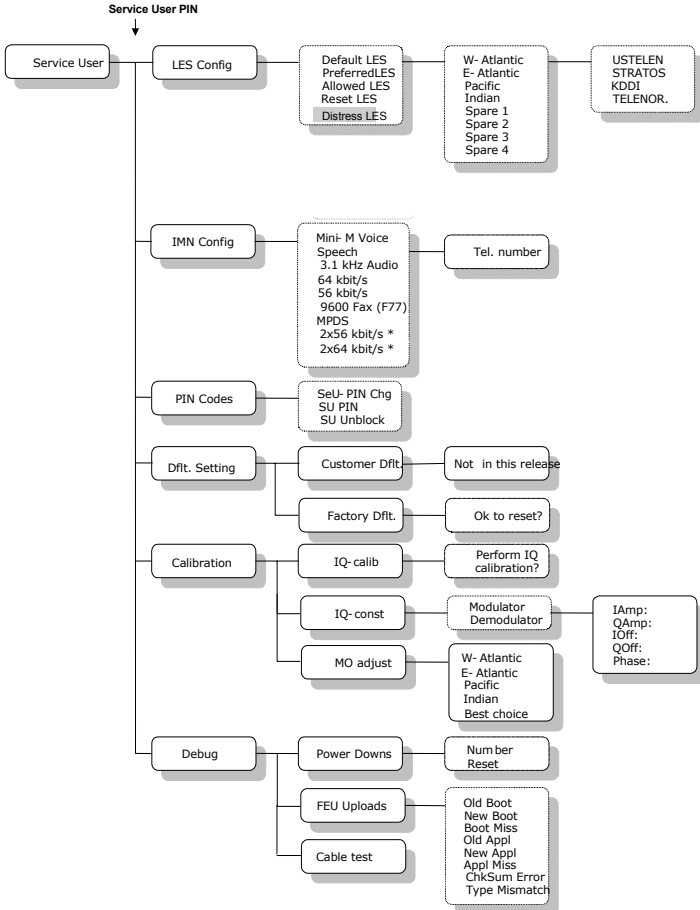

\*) Only on F77 and if the service is enabled



## **A**

ACU	Antenna Control Unit
ADU	Above Deck Unit
AORE	Atlantic Ocean Region East
AORW	Atlantic Ocean Region West

## **B**

BDU	Below Deck Unit
-----	-----------------

## **F**

FEU	Front End Unit
-----	----------------

## **G**

GPS	Global Positioning System
-----	---------------------------

## **I**

IMN	Inmarsat Mobile Number
IMSO	International Maritime Satellite Organisation
IOR	Indian Ocean Region
ISDN	Integrated Services Digital Network
ISN	Inmarsat Serial Number
ISP	Inmarsat Service Provider

**L**

LCD	Liquid Crystal Display
LED	Light Emitting Diode
LES	Land Earth Station

**M**

MES	Mobile Earth Station
MMI	Man Machine Interface
MPDS	Mobile Packet Data Service
MSN	Mobile Subscriber Number

**N**

NCS	Network Coordination Station
NSR	Network Status Record

**P**

PABX	Private Automatic Branch eXchange
PIN	Personal Identification number
POR	Pacific Ocean Region
PSTN	Public Services Telephone Network
PUK	Personal Unblocking Key, or PIN Unblocking Key

**R**

RCC                      Rescue Coordination Center

**S**

STE                      Secure Telephone Equipment

STU                      Secure Telephone Unit

**T**

T&T                      Thrane & Thrane A/S

TNID                     Terrestrial Network ID

**U**

UDI                      Unrestricted Digital Information

USB                      Universal Serial Bus





## Numerics

128 kbps, 16, 47, 67, 87  
2nd functions, 29  
3.1 kHz audio, 4, 67  
56 kbps, 4, 67  
64 kbps, 4, 45, 67

## A

ACU, 77, 102  
additional features, 87  
ADU, 8, 11  
alarm, 25, 55, 133  
alarm Log, 55, 80  
allowed dial mask, 73  
alpha-numeric keys, 31  
antenna, 7, 10, 102  
Area, 52, 53  
AT commands, 103  
Azimuth, 94

## B

barring, 75, 100  
Baud rate, 69, 105  
BDU, 7, 10  
brightness, 76, 101  
bulletin board, 85

## C

C/No, 57  
call log, 64  
Call Waiting notification, 45, 89  
calling the terminal, 42  
Cause Codes, 133

company addresses, ii  
configuration module, 8, 11  
connectors, 13  
contact information, ii  
contrast, 69, 101  
country code, 5

## D

data flow, 69  
Data Limits, 88  
data setup, 69  
date, 71, 99  
Dial-Up networking, 108, 110, 116  
discrete I/O, 13, 19  
Distress button, 9, 43, 79  
Distress call, 9, 43, 62  
Distress cradle, 7, 43, 79  
distress LES, 43, 79  
Distress Test, 79  
document number  
    this manual, i

## E

electronics unit, 7, 10  
Elevation, 94  
email, 45  
Ethernet, 13, 66

## F

fax, 61  
file transfer, 45  
FleetCP, 93  
function keys, 26

## G

geostationary, 3  
GPS, 8, 11, 72

## H

handset, 7, 10, 13, 22, 66  
Help Desk, 55, 81

## I

IMN, 5, 67, 98  
Inmarsat Fleet service, 3  
internal calls, 63  
international access codes, 42  
Internet Explorer, 110, 116  
IP/LAN, 45  
ISDN, 13, 16, 47, 61, 66  
ISN, 57  
ISP, 5

## K

Key Beep, 70  
keys, alphanumeric, 31  
keys, function, 26

## L

language, 99  
LED, 76  
LES, 3, 53, 85, 97

## M

Mailbox, 54, 82

manual

document number, i  
mask, allowed dial, 73  
menu, 49  
microwave radiation, iii  
Mini-M voice, 4  
mounting position, 78, 102  
MPDS, 4, 45, 104

## N

Network Coordination Stations, 3  
NMEA, 13, 18, 72  
Normal User, 39, 49

## O

ocean region, 52, 85  
Outlook Express, 110, 116

## P

phone book, 50, 60, 96  
PIN code, 39, 82, 87, 95  
position, 72  
power, 25  
Power button, 35, 36, 38  
PPPoE, 128, 130  
preempt, 43, 79  
prefix, 41, 74, 100  
Priority call, 44, 62  
PUK code, 40

## R

radiation, iii  
RCC, 43

---

redial, 60  
Ring setup, 70, 101  
ringing tone, 70  
RJ11, 13, 15, 60, 61, 63, 66, 83  
Routine-personal, 62  
Routine-professional, 62  
routing, 98  
RS-232, 13, 17, 66, 69, 102, 104

## S

Safety call, 62  
satellite, 3  
Secure Telephone Unit, 87  
Service User, 40, 49  
services, 6  
setup using Ethernet & PPPoE, 128  
short code, 50, 60  
short message, 54, 82  
sky scans, 77, 102  
software version, 57  
Speech, 4  
spot beams, 3  
Status, 56  
Stop button, 9  
STU, 87  
Super User, 40, 49  
support phone numbers, ii

## T

time, 71, 99  
time out, 77, 102  
TNID, 86

## U

Urgency call, 62

USB, 13, 66, 117

## V

volume, 70, 101

## W

warning Log, 81  
web browsing, 45  
Windows 2000 and PPPoE, 130  
Windows XP and PPPoE, 128





**KVH Industries, Inc.**

50 Enterprise Center • Middletown, RI 02842-5279 • U.S.A.  
Phone: +1 401 847-3327 • Fax: +1 401 849-0045  
E-mail: [info@kvh.com](mailto:info@kvh.com) Internet: [www.kvh.com](http://www.kvh.com)

**KVH Europe A/S**

Kokkedal Industripark 2B 2980 Kokkedal Denmark  
Phone: +45 45 160 180 Fax: +45 45 160 181  
E-mail: [info@kvh.dk](mailto:info@kvh.dk) Internet: [www.kvh.com](http://www.kvh.com)