

**KVH Industries, Inc.**

# TracPhone® V3



## User's Guide

# TracPhone V3

## mini-VSAT Broadband<sup>sm</sup> System

### User's Guide

This user's guide provides all of the basic information you need to operate, set up, and troubleshoot the TracPhone V3 system. For detailed installation information, please refer to the *TracPhone V3 Installation Guide*.

**If you have any comments regarding this manual, please e-mail them to [manuals@kvh.com](mailto:manuals@kvh.com). Your input is greatly appreciated!**



#### Serial Numbers



Antenna



Control Unit



Modem

#### Technical Support

##### **Within the Continental U.S.A.:**

Phone: 1 866 701-7103 (via landline)

E-mail: [mvbsupport@kvh.com](mailto:mvbsupport@kvh.com)

##### **North/South America, Australia:**

Phone: +1 401 851-3806

E-mail: [mvbsupport@kvh.com](mailto:mvbsupport@kvh.com)

##### **Europe, Middle East, Asia, Africa:**

Phone: +45 45 160 180

E-mail: [support@kvh.dk](mailto:support@kvh.dk)

## **Trademark Information**

TracPhone, KVH, and the unique light-colored dome with dark contrasting baseplate are registered trademarks of KVH Industries, Inc.

mini-VSAT Broadband is a service mark of KVH Industries, Inc.

ViaSat and the ViaSat logo are registered trademarks of ViaSat, Inc.

All other trademarks are the property of their respective owners.

## **Disclaimer**

Every effort has been made to ensure the correctness and completeness of the material in this document. No company shall be liable for errors contained herein. The information in this document is subject to change without notice. No warranty of any kind is made with regard to this material, including, but not limited to, the implied warranties of merchantability and fitness for a particular purpose.



## CE Declaration of Conformity

The undersigned of this letter declares that the following equipment complies with the specifications of EC directive 1999/5/EC Radio & Telecommunications Terminal Equipment.

### Equipment Included in this Declaration

- 02-1860 TracPhone V3 Antenna
- 02-1601 TracPhone V3 Antenna Control Unit
- 19-0487 TracPhone V3 Modem

### Equipment Applicability

The TracPhone V3 is a system that provides broadband internet connectivity between a ship and any destination in the world. The equipment is not intended for SOLAS applications.

### Declaration and Certification

The TracPhone V3 system complies with the following harmonized standards under the R&TTE Directive 1999/5/EC:

Essential Requirement		Applied Standard(s)
Article 3.1(a)	Health & Safety	EN60950-1:2006 + A1:2009
Article 3.1(b)	EMC	EN 301 843-1 v1.2.1:2004-06, EN 301 843-6 V1.1.1:2006-01, EN61000-3-2:2006 EN61000-3-3:1995, A1:2001 & A2:2005, EN60945:2002
Article 3.2	Spectrum Efficiency	EN302 340 V1.1.1:2006-04

### Manufacturer

KVH Industries, Inc.  
50 Enterprise Center  
Middletown, RI 02842-5279  
USA

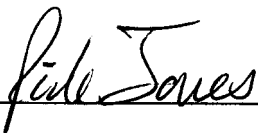
  
\_\_\_\_\_

Rick Jones, Director of Corporate Quality

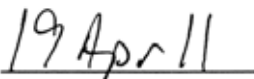
  
\_\_\_\_\_

Date



# Table of Contents

<b>1</b>	<b>Introduction</b>	
	Using this Manual .....	3
	Important Safety Information .....	5
	System Overview .....	6
<b>2</b>	<b>Operation</b>	
	Satellite Communication Basics .....	11
	Turning On the System .....	12
	System Startup .....	13
	Using the mini-VSAT Broadband Service .....	14
	Using KVH's Enhanced Voice Service .....	15
<b>3</b>	<b>Configuration</b>	
	Adjusting the Control Unit Display Brightness .....	23
	Configuring RF Radiation Hazard Zones .....	25
	Resetting the System to Factory Conditions .....	33
	Configuring Your Computer for mini-VSAT Broadband .....	35
	Requesting Static IP Addressing .....	43
<b>4</b>	<b>Troubleshooting</b>	
	Five Simple Checks .....	47
	Control Unit Status Lights .....	48
	Modem Status Light .....	50
	Error Messages .....	51
	Troubleshooting a Voice Service Problem .....	56
	Viewing Status Information on Your Web Browser .....	57

Viewing Status Information on the Control Unit .....63  
Calibrating the Antenna Gyros .....70  
Technical Support .....72

**A Wiring Diagram**  
Wiring Diagram .....75

**B Menus Quick Reference Guide**  
Menus Quick Reference Guide.....79

**C Glossary**  
Glossary .....83



# 1. Introduction

This chapter provides a basic overview of this manual and your TracPhone system. It also provides important safety information you need to know before using the product.

## Contents

Using this Manual .....	3
Important Safety Information .....	5
System Overview .....	6





## Using this Manual

This manual provides complete operation, configuration, and troubleshooting information for your TracPhone V3 system.

### Who Should Use this Manual

The **user** should refer to the “Operation” chapter to learn how to operate the system.

The **user** or **installer** should refer to the “Configuration” chapter for information on setting up the system for the desired preferences.

The **user** and/or **servicing technician** should refer to the “Troubleshooting” chapter to help identify the cause of a system problem.

### Icons Used in this Manual

This manual uses the following icons:

Icon	Description
	This is a danger, warning, or caution notice. Be sure to read these carefully to avoid injury!

Icon
<div style="display: flex; justify-content: space-around; text-align: center;"> <div style="border: 1px solid black; border-radius: 15px; padding: 5px; width: 20%;">             MENUS ▼           </div> <div style="border: 1px solid black; border-radius: 15px; padding: 5px; width: 20%; background-color: #cccccc;">             CHANGE ◻           </div> <div style="border: 1px solid black; border-radius: 15px; padding: 5px; width: 20%;">             ACCEPT ✓           </div> <div style="border: 1px solid black; border-radius: 15px; padding: 5px; width: 20%;">             EXIT ✕           </div> </div>
Description
This is an illustration of the buttons on the control unit. Gray shading indicates which button the user should press.



## Typographical Conventions

This manual uses the following typographical conventions:

Text Example	Description
Press ▼MENUS to view the menu	Both the icon and the name of the button are provided
SELECT SATELLITES	Text as it appears on the control unit display
The display shows "BRIGHTNESS"	Text in quotes is shown on the control unit display
See <a href="#">"Using this Manual" on page 3.</a>	Cross-reference to another chapter in the manual
Visit <a href="http://www.kvh.com/mvbservice">www.kvh.com/mvbservice</a> for details.	Cross-reference to a website

## Related Documentation

In addition to this User's Guide, the following documents are provided with your TracPhone system:

Document	Description
Installation Guide	Complete installation instructions
Quick Start Guide	Handy quick reference guide with basic operating instructions
Activation Checklist	Details on activating the system for mini-VSAT Broadband service
Installation Checklist	Form that the installer must return to validate the quality of the installation
Antenna Mounting Template	Template that the installer uses to lay out the antenna mounting holes
Warranty Statement	Warranty terms and conditions
Contents List	List of every part supplied in the kit

## Important Safety Information



For your own safety, and for the safety of your passengers and/or crew, be sure to read the following important notices.

### Warning - Risk of Electric Shock

Potentially lethal voltages are present within the control unit and the modem. To avoid electric shock, do not open the chassis enclosures of the belowdecks equipment. They contain no user-serviceable parts, and opening the enclosure(s) will void the product's warranty.

### Warning - Risk of Electric Shock

The system requires 3-wire single-phase AC power. Running the system on two-phase, split-phase, or delta power will cause an unsafe floating ground condition in which the equipment's chassis ground will differ greatly from ship's ground, risking potentially lethal electric shock. Refer to the *Installation Guide* for details.

### Caution - RF Radiation Hazard

The antenna transmits radio frequency (RF) energy that is potentially harmful. Whenever the system is powered on, make sure everyone stays more than 32 feet (10 m) away from the antenna. No hazard exists directly above the antenna and anywhere below the antenna's mounting plane.

Figure 1-1 Minimum Safe Distance to Avoid Risk of RF Radiation Exposure

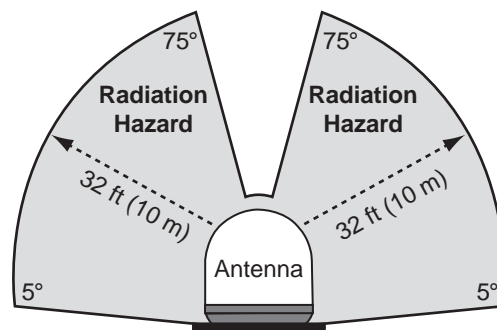

- If a person is standing outside the antenna's main transmission beam, minimum safe distance is 1 foot (0.3 m). However, since a person may not know which direction the antenna is pointing, always observe the full 32 feet (10 m) minimum safe distance.
- You can set up RF radiation hazard zones to inhibit transmissions within areas frequented by your passengers and/or crew. See [“Configuring RF Radiation Hazard Zones”](#) on page 25 for details.

## System Overview

Your TracPhone V3 is a complete mini-VSAT Broadband communications system for mariners on the move. Using cutting-edge spread spectrum technology, which was previously only available to the military and corporate jets, the TracPhone V3 delivers a seamless and consistent Internet experience. And it all comes with an antenna that is much smaller and lighter than traditional VSAT antennas.

As shown in the basic diagram below, the system consists of an antenna system, control unit, and modem that connect to a land-based hub via a Ku-band satellite. The hub, managed by a Network Operations Center, then provides the link to the Internet and the terrestrial telephone network. A brief description of each system component is provided on the following page. A detailed wiring diagram is provided in ["Wiring Diagram" on page 75](#).

Figure 1-2 TracPhone V3 mini-VSAT Broadband Network Diagram

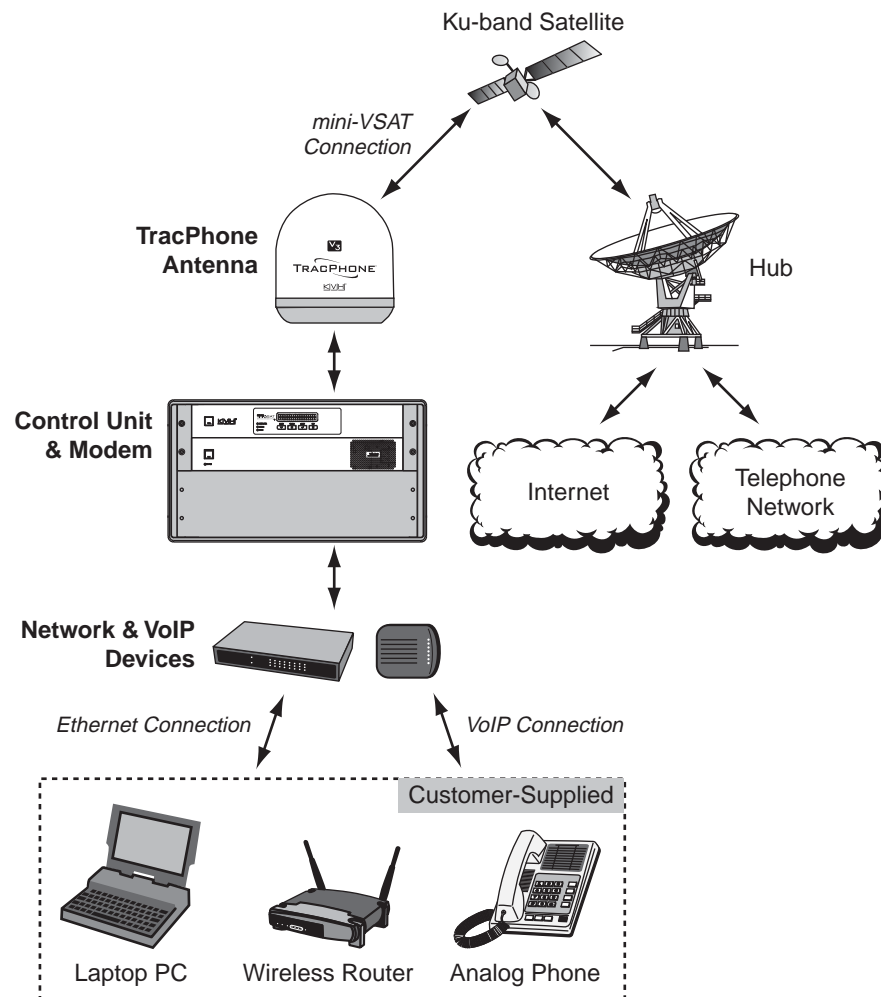

## System Components

The TracPhone V3 system includes the following components:

The **antenna unit** provides the satellite link between the onboard modem and the land-based hub. Using its integrated GPS, advanced reflector technology, and gyro stabilization, the antenna automatically locates and tracks the correct satellite, even while your vessel is on the move.



The **control unit** links the antenna to the modem and allows you to operate and configure all aspects of the system.



The **modem**, manufactured by ViaSat, is the transceiver and “brain” of the system. It processes all incoming and outgoing TCP/IP data between the antenna and the switch using its proprietary spread spectrum technologies.



The **multimedia terminal adapter (MTA)** is a Voice over IP (VoIP) device that allows you to connect an analog telephone and make and receive calls over the mini-VSAT Broadband connection.



The **switch** links the system to your onboard local area network (LAN) via wired Ethernet connections. Four of its eight ports support Power over Ethernet (PoE) - they can supply power to any IEEE 802.3af-compliant device, such as a wireless access point.



## Service Activation

Before you can start using the TracPhone V3, you need to activate the system for mini-VSAT Broadband service. To activate, fill out and submit the following forms:

- **KVH TracPhone V3 Service Activation Form**  
Complete the leisure or commercial form, as appropriate
- **End User Agreement**  
Read and initial each page in the bottom right-hand corner
- **Airtime Account Authorized Representative Form**  
Complete, if applicable

All forms are available in PDF format at [www.kvh.com/mvbservice](http://www.kvh.com/mvbservice). The PDF versions include blank fields, allowing you to fill out the forms on your computer.

Fax or e-mail the completed forms to KVH:

**North/South America, Australia:**

Fax: +1 401 851-3823

E-mail: [satelliteservices@kvh.com](mailto:satelliteservices@kvh.com)

**Europe, Middle East, Asia, Africa:**

Fax: +45 45 160 181

E-mail: [airtime@kvh.dk](mailto:airtime@kvh.dk)

Once KVH processes these forms, activates your account, and registers your product, you will receive an e-mail with the details of your new service, including phone numbers, as well as a link to create a customer account on [www.kvh.com](http://www.kvh.com). Your account will provide details of your TracPhone V3 system, links to your airtime and voice accounts, and a wealth of information for your product, all in one convenient location.





# 2. Operation

This chapter explains how to turn on and use the TracPhone V3 system. It also explains how to interpret the startup screens.

## Contents

Satellite Communication Basics .....	11
Turning On the System .....	12
System Startup .....	13
Using the mini-VSAT Broadband Service.....	14
Using KVH's Enhanced Voice Service .....	15



## Satellite Communication Basics

Ku-band communications satellites are located in fixed positions above the Earth's equator and relay data to/from the earth within the regions that they serve. Therefore, to communicate via a given satellite, you must be located within that satellite's unique coverage area, also known as its "footprint."

**TIP:** To view the latest mini-VSAT Broadband satellite coverage map, visit our website at [www.kvh.com/minivsatmap](http://www.kvh.com/minivsatmap).

Figure 2-1 Example of a Satellite Footprint

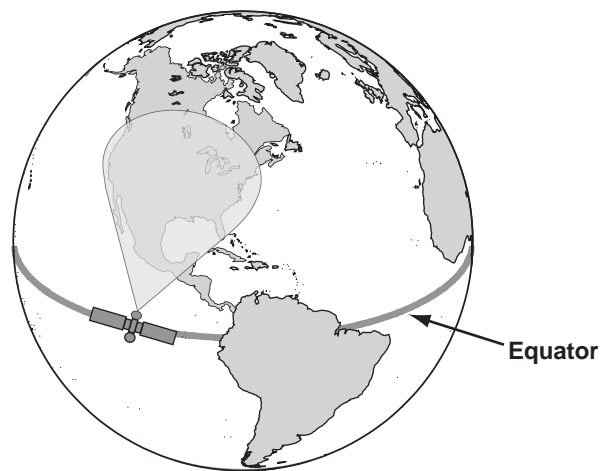

In addition, since satellites are located 22,300 miles (35,900 km) above the equator, the TracPhone antenna must have a clear view of the sky to transmit and receive signals. Anything that stands between the antenna and the satellite can block signals, resulting in lost data. Common causes of blockage include trees, buildings, and bridges. Heavy rain, ice, or snow may also temporarily interrupt reception.

Figure 2-2 Example of Satellite Blockage

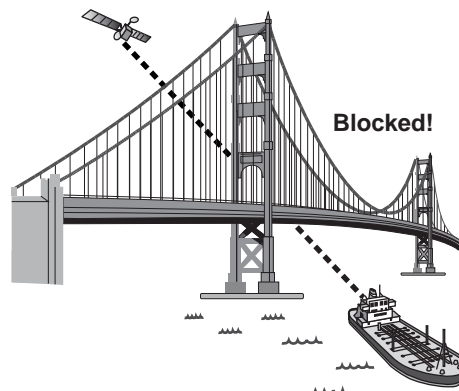

## Turning On the System

Follow the steps below to turn on your TracPhone system.

**CAUTION**

The antenna transmits RF energy that is potentially harmful. Make sure everyone stays more than 32 feet (10 m) away from the antenna within its 5°-75° elevation range while it is in use. No hazard exists directly above the antenna and anywhere below its mounting plane.

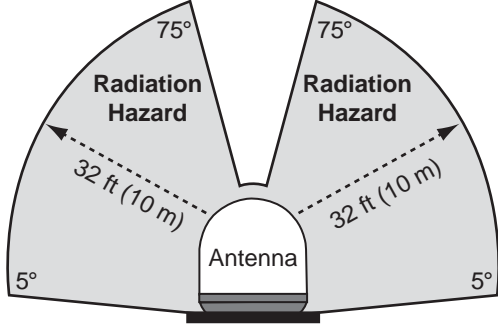

1. Make sure the antenna has a clear view of the sky.
2. Make sure power is applied to the modem, control unit, switch, MTA, and computer(s).
3. Press the power button on the modem. The button's light should illuminate green.

Figure 2-3 Modem Front Panel Power Switch



4. Press the power button on the control unit. The button's light should illuminate green. The control unit supplies power to the antenna.

Figure 2-4 Control Unit Front Panel Power Switch

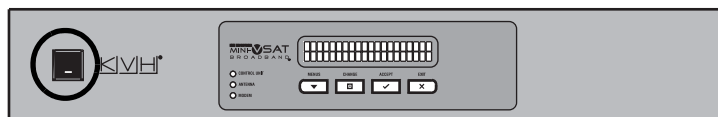

5. Turn on your networked computer(s).
6. Wait five minutes for system startup (see the next section for details).

Once the antenna finds the correct service satellite, all status lights on the control unit and the modem should be lit green. If any lights are not lit green, refer to [“Troubleshooting” on page 45](#).



## System Startup

The control unit shows the following screens during startup. If the display shows an error message, see [“Error Messages” on page 51](#).

Control Unit Screen	Description
<div style="border: 1px solid black; border-radius: 10px; padding: 5px; text-align: center;"> <b>ANTENNA INITIALIZING</b> </div>	The antenna is running a self test routine
<div style="border: 1px solid black; border-radius: 10px; padding: 5px; text-align: center;"> <b>GPS: ACQUIRED</b>  <b>41.5198N, 123.5817W</b> </div>	When GPS acquires a fix, momentarily displays your latitude/longitude
<div style="border: 1px solid black; border-radius: 10px; padding: 5px; text-align: center;"> <b>ANTENNA READY</b>  <b>WAITING FOR MODEM</b> </div>	The antenna is waiting for the modem to initialize
<div style="border: 1px solid black; border-radius: 10px; padding: 5px; text-align: center;"> <b>MODEM COMMS: OK</b> </div>	The modem is communicating with the control unit
<div style="border: 1px solid black; border-radius: 10px; padding: 5px; text-align: center;"> <b>RECEIVING SATELLITE</b>  <b>INFO FROM MODEM</b> </div>	The modem is providing satellite identification data to the antenna
<div style="border: 1px solid black; border-radius: 10px; padding: 5px; text-align: center;"> <b>SEARCHING FOR 72.0W</b>  <b>SERVICE SATELLITE</b>  <i>Note: Satellites will vary</i> </div>	The antenna is searching for the mini-VSAT Broadband service satellite
<div style="border: 1px solid black; border-radius: 10px; padding: 5px; text-align: center;"> <b>TRACKING 72.0W</b>  <b>SERVICE SATELLITE</b> </div>	The antenna is now tracking the service satellite
<div style="border: 1px solid black; border-radius: 10px; padding: 5px; text-align: center;"> <b>ONLINE</b>  <b>TRACKING 72.0W</b> </div>	The modem has accessed the mini-VSAT Broadband service; the system is ready for use!

## Using the mini-VSAT Broadband Service

Once the TracPhone V3 modem establishes a connection with the mini-VSAT Broadband service, you can perform all of the same Internet tasks you perform at home:

- E-mail
- Internet browsing
- Weather and chart updates
- Instant messaging
- Accessing corporate networks (VPNs)
- Data transfers

**IMPORTANT!**

Be sure to read all of the service terms and conditions in the End User Agreement, which can be found at [www.kvh.com/mvbservice](http://www.kvh.com/mvbservice).

**NOTE:** *The system must be activated before you can use it. See “Service Activation” on page 8 for details.*

## Using KVH's Enhanced Voice Service

The MTA and enhanced voice service allow you to make/receive calls via the mini-VSAT Broadband service. This section explains how to use the enhanced voice service.

**IMPORTANT!**

The TracPhone V3 voice service will not provide Automatic Number Identification or Automatic Location Information capabilities associated with emergency **911** or **E911** services. In addition, the voice service will not work in the event of either a network service outage or a power failure. Therefore, it is critical that you maintain your vessel's separate distress and safety communications system for emergency calls. Be sure to inform anyone who may use the TracPhone V3 of the limitations of 911 and E911 emergency services. *The manufacturer, distributor, and service provider shall not be liable for, and expressly disclaim, any direct or indirect damages, claims, losses, expenses, liabilities, actions, risks, or harms arising out of or related to the services provided through this equipment, including without limitation, emergency 911 or E911 services.*

### Turning On the MTA

The MTA has no on/off switch. When you turn on the TracPhone V3 system, the MTA initializes, which may take up to 15 minutes. The MTA is ready once its "VOIP" light is lit steady green (see Figure 2-5). *For complete details about the MTA device, refer to the MTA User's Guide.*

Figure 2-5 MTA Status Lights

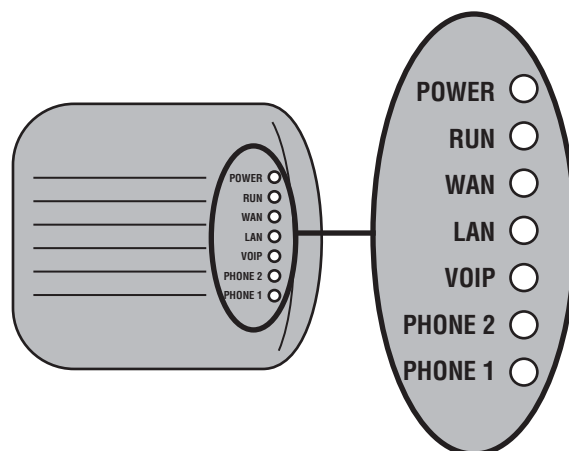

## Placing a Voice Call

For your convenience, you may assign a **dial plan** to the MTA that allows you to dial outgoing calls from the vessel to your home country as if they are in-country calls. For example, if Copenhagen is your home port, you could assign a Denmark dial plan to the MTA, allowing you to call home without the hassle of dialing an international prefix and country code first. To assign a dial plan, access your voice account online (see [“Managing Your Voice Account Online” on page 19](#)) and select “Dial Plan & Time Zone.”

To place a call, you need to dial the number as if you are calling from the chosen dial plan's designated country (*United States is the default*), regardless of your vessel's location. Follow the steps below.

1. Make sure the system is turned on and connected to the mini-VSAT Broadband service (the control unit shows “Online”).
2. Make sure the “VOIP” light on the MTA is lit green.
3. Make sure another phone call is not in progress (the “PHONE 1” light on the MTA is not lit green). The TracPhone V3 supports just one call at a time.
4. Pick up the handset on any phone connected to the MTA's “PHONE 1” jack. You should hear a dial tone.
5. Dial the phone number you wish to call.

### **Within the dial plan's country:**

If you are calling a number within the dial plan's country, dial it as an in-country call. For example, if your MTA is assigned a United States dial plan (*default setting*) and you are calling a U.S. number, dial **Area/City Code + Local Phone Number**.

### **Outside your dial plan's country:**

If you are calling a country that is outside your dial plan, dial it as an international call. For example, if your MTA is assigned a United States dial plan (*default setting*) and you are calling a number outside of the U.S., dial **011 + Country Code + Area/City Code + Local Phone Number**.

*When you make a call via the mini-VSAT Broadband service, your voice travels 22,300 miles (35,900 km) into space, then 22,300 miles (35,900 km) back to Earth, just like any other satellite voice service. This lengthy transit will necessarily cause a brief delay (approximately 0.5 second) in your telephone conversations, even at the fastest speeds.*



## Phone Numbers for Incoming Calls

During activation, your MTA's phone line was assigned a phone number with the country code and area/city code of your choice. This allows people on shore within that region to call your vessel and avoid long distance or international calling charges, regardless of your vessel's location.

For an additional monthly fee, you may associate up to five virtual "local numbers" to your MTA's phone line, allowing people calling from additional countries to avoid long distance or international fees. For example, if you are running a business from your vessel, and you have many customers who live in France, you could set up a virtual number that allows customers in France to call your vessel using a French "local number." To set up virtual phone numbers, contact KVH's Airtime Services Department (see "[Service Activation](#)" on [page 8](#) for contact information).

## Recording a VoiceMail Personal Greeting

Follow the steps below to record your VoiceMail personal greeting.

1. Pick up the handset on any phone connected to the MTA. You should hear a dial tone.
2. Dial **123#** on the telephone keypad to connect to the VoiceMail system.
3. Press **2** to access your mailbox.
4. Press **1** to access your personal greeting.
5. Press **2** to change your greeting. You will be prompted to record your greeting.
6. Press **1** to listen to your personal greeting.
7. When you are satisfied with your greeting, press **3** to accept and activate your greeting. You will hear the message "Your personal greeting has been activated."

## Listening to Your VoiceMail Messages

If the "PHONE 1" light on the MTA is blinking orange when the telephone handset is on the hook, you have new VoiceMail messages (see [Figure 2-5 on page 15](#)). Follow the steps below to listen to your VoiceMail messages.

1. Pick up the handset on any phone connected to the MTA. You should hear a dial tone.
2. Dial **123#** on the telephone keypad to connect to the VoiceMail system.
3. Press **1** to listen to your messages.
4. Follow the spoken instructions to listen to, save, and/or delete your messages.

**NOTE:** You can also listen to your messages online at your voice account web page (see ["Managing Your Voice Account Online" on page 19](#)). In addition, you can access VoiceMail from any regular landline telephone. Simply dial the number for your phone line, press \*, then enter your PIN (provided during service activation).



## Sending or Receiving a Fax

You can also fax documents via the enhanced voice service. Connect a fax machine to the “PHONE 1” jack on the MTA and dial as you would a voice call (see “[Placing a Voice Call](#)” on page 16).

**NOTE:** *Faxing requires 70k bandwidth for sending and up to 90k bandwidth for receiving.*

Faxing over Internet Protocol can be unreliable at times. Therefore, if you require an enterprise-grade fax solution, install KVH’s optional UCH-250 Fax Server (KVH part #19-0520). When you activate its corresponding fax service, the UCH-250 gives you an additional phone number dedicated for faxing, freeing up the “PHONE 1” jack on the MTA. Contact your dealer/distributor for details.

## Managing Your Voice Account Online

You can manage your account online at your Enhanced Voice Service web page. You can view and configure all of the various calling features available to you, as well as view account information and listen to VoiceMails. To log onto the site, follow the steps below:

1. Go to <http://kvh.myaccountcenter.net>.
2. At the login page, enter your primary phone number and PIN (*provided during service activation*).

**NOTE:** *You may also navigate to this site from [www.kvh.com/your-account](http://www.kvh.com/your-account).*

**NOTE:** *You can also contact Customer Support by dialing 611 on your telephone handset.*



# 3. Configuration

This chapter explains how to change the brightness of the control unit's display, set up an RF radiation hazard zone, and reset the system to its factory configuration. It also explains how to configure your computer for a wired Ethernet connection to the TracPhone V3 system. For details on setting up a wireless network, refer to the instructions provided with your wireless access point (purchased separately).

## Contents

Adjusting the Control Unit Display Brightness.....	23
Configuring RF Radiation Hazard Zones .....	25
Resetting the System to Factory Conditions.....	33
Configuring Your Computer for mini-VSAT Broadband....	35
Requesting Static IP Addressing .....	43





## Adjusting the Control Unit Display Brightness

Follow the steps below to adjust the brightness of the control unit's front panel display.

1. Press ▼MENUS until the display shows "CONFIGURATION."

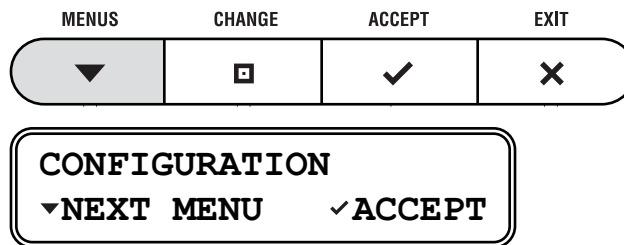

2. Press ✓ACCEPT.

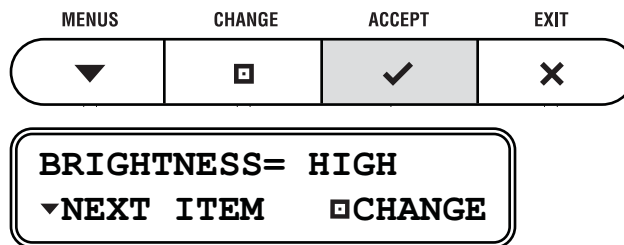

3. Press □CHANGE until the display shows the desired brightness setting: **HIGH**, **MEDIUM**, or **LOW**.

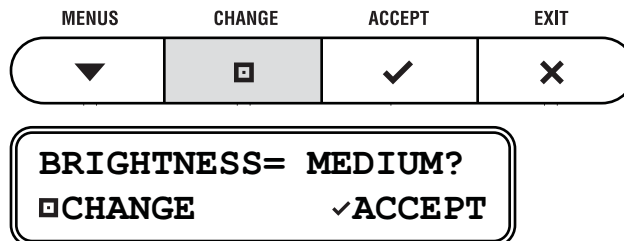

4. Press ✓ACCEPT.

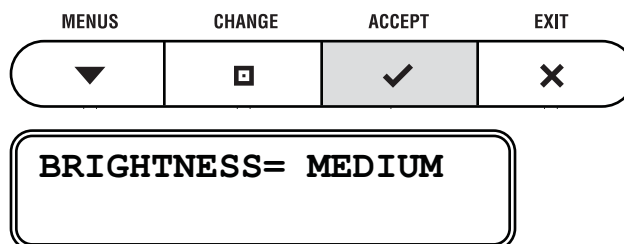

5. Press \*EXIT to exit the menu.

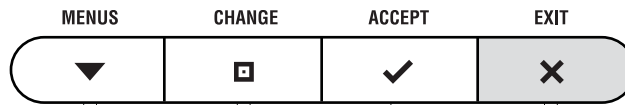

## Configuring RF Radiation Hazard Zones

To prevent exposure to the antenna's radiated RF energy, you can configure up to two RF radiation hazard zones for areas where crew and/or passengers frequent. (See [“Important Safety Information” on page 5](#) for details on minimum safety distances.)

When determining the need for a hazard zone, keep in mind that the antenna transmits within an elevation range of 5°-75°. Therefore, you do not need to consider any areas that are below the antenna's mounting plane, since they are safe from radiation exposure.

Figure 3-1 Example of an RF Radiation Hazard Zone

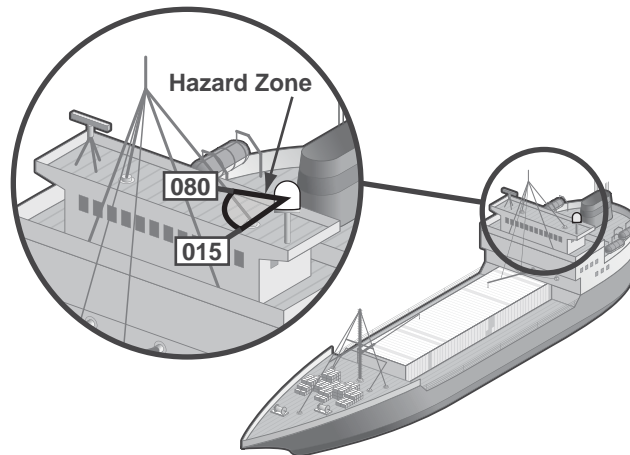

Whenever the antenna points within an RF radiation hazard zone, the system will disable the transmitter and the control unit will display the following message:

**RF RADIATION HAZARD!  
TRANSMIT INHIBITED**

Once the antenna points outside the hazard zone, transmission capability will be restored.

## Defining an RF Radiation Hazard Zone

Follow the steps below to configure an RF radiation hazard zone.

1. Determine the necessary azimuth range for the RF hazard zone. You will need to enter the beginning and ending azimuths that define the outer boundaries of the zone, **relative to the antenna's forward arrow**, which should be pointing toward the bow (see Figure 3-2).

**NOTE:** Each RF hazard zone must span at least 5°. Therefore, be sure to set beginning and ending azimuths at least 5° apart.

Figure 3-2 Beginning and Ending Azimuths Defining RF Radiation Hazard Zone

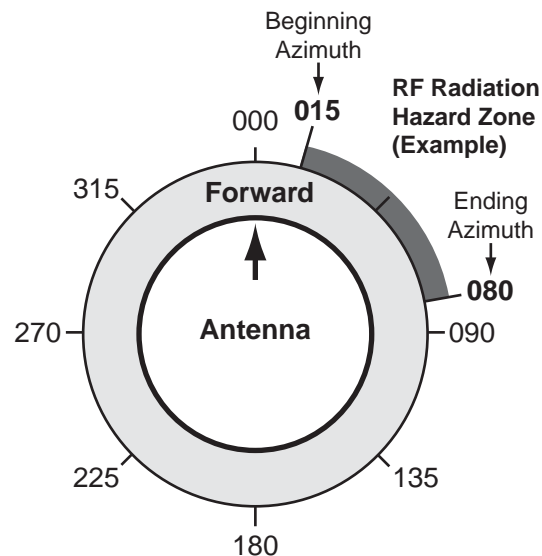

2. Press ▼MENUS until the display shows "CONFIGURATION."

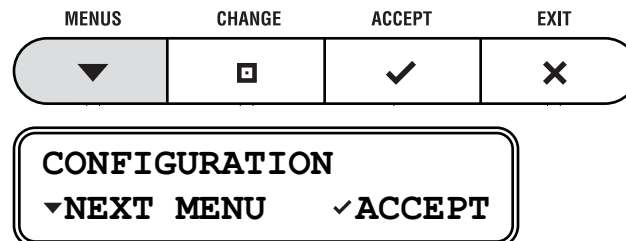

3. Press ✓ACCEPT.

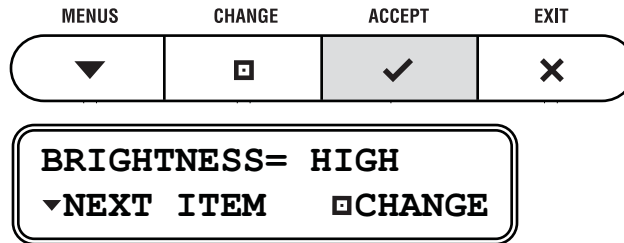

4. Press ▼MENUS until the display shows "SET HAZARD ZONE."

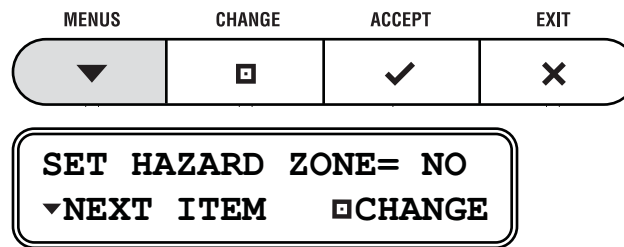

5. Press □CHANGE until the display shows "SET HAZARD ZONE = YES."

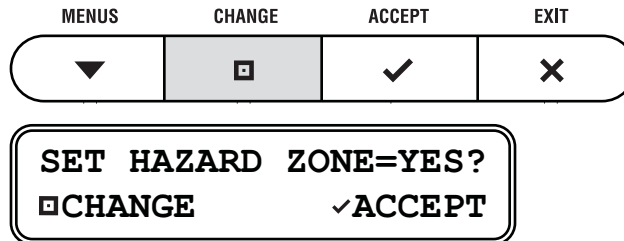

6. Press ✓ACCEPT.

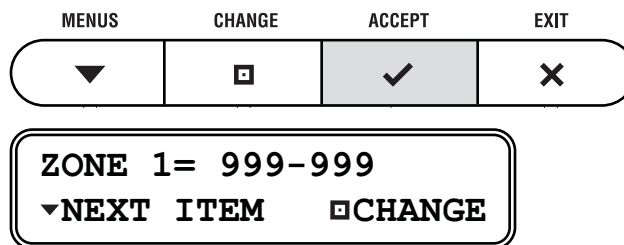

- Press CHANGE. A cursor appears under the first number in the displayed azimuth range for RF radiation hazard zone #1. If no zone is currently configured, the display shows 999-999.

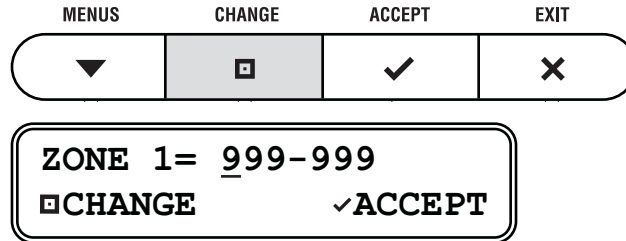

- Press CHANGE until the number is set to the first digit of the beginning azimuth for zone #1. *If the azimuth value is less than 100°, set the first digit to zero.*
- Press ACCEPT. The cursor moves to the next number.

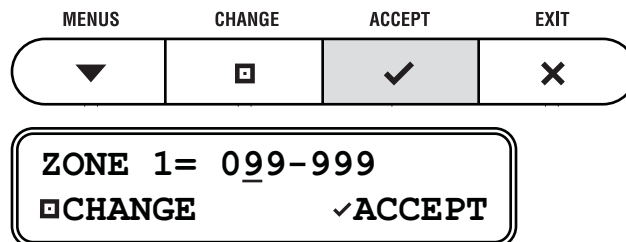

- Repeat steps 8 and 9 to set the remaining digits of the range of azimuths for zone #1. Once you have set the entire range, the cursor disappears from the display.

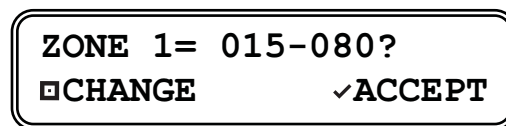

- Press ACCEPT. The display shows the current azimuth range for RF radiation hazard zone #2.

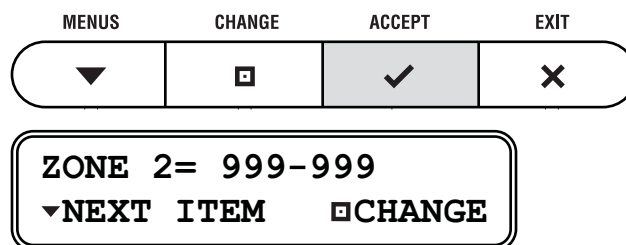

12. If you wish to set up a second RF radiation hazard zone, repeat steps 7-11. (*Be sure the second zone does not overlap the first.*) Otherwise, press ▼MENUS. The display shows the current setting for Transmit Inhibition (“XMT IN ZONES”).

**IMPORTANT!**

Make sure “XMT IN ZONES” is set to **NO**, so the antenna will not transmit whenever it points within one of your configured RF radiation hazard zones. If “XMT IN ZONES” is set to YES, the zones are disabled, allowing the antenna to transmit within them.

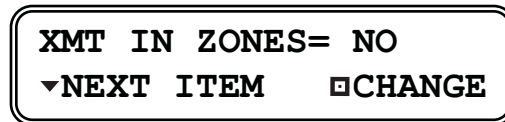
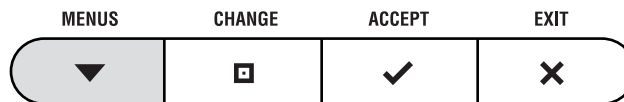

13. If the display shows “XMT IN ZONES = NO,” press ▼MENUS.  
 If the display shows “XMT IN ZONES = YES,” press ▣CHANGE until the display shows “XMT IN ZONES = NO.” Then press ✓ACCEPT.

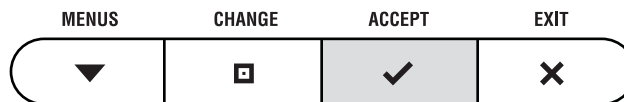
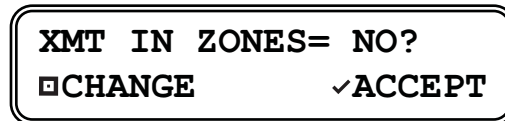
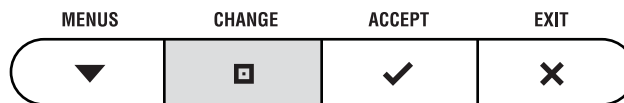

14. Press ✕EXIT to exit the menu.

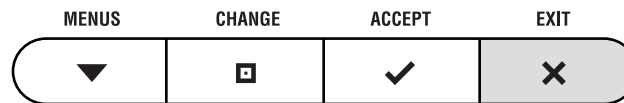

## Disabling RF Radiation Hazard Zones

If you wish to remove all restrictions on transmissions, follow the steps below to disable your programmed RF radiation hazard zones. This function simply disables the hazard zones; it does not delete them from memory.

	<b>CAUTION</b>
<p>Disabling RF radiation hazard zones allows the antenna to transmit in any direction, even if the antenna is pointing in an area accessible to passengers and crew. Make certain that everyone stays a minimum safe distance away from the antenna before you transmit. Also be sure to return to this menu and restore the hazard zones when you are done transmitting.</p>	

**NOTE:** You can view the currently programmed hazard zones in the control unit's Antenna Status menu (see "[Antenna Status Information](#)" on page 66).

1. Press ▼MENUMS until the display shows "CONFIGURATION."

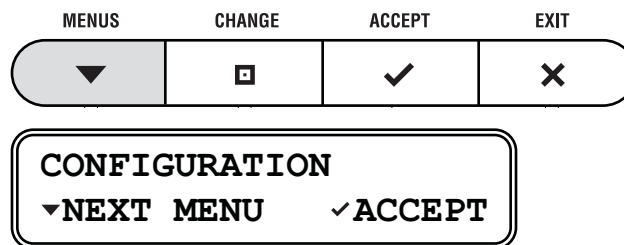

2. Press ✓ACCEPT.

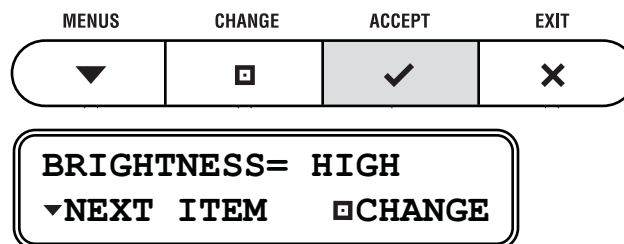



- Press ▼MENUS until the display shows "SET HAZARD ZONE."

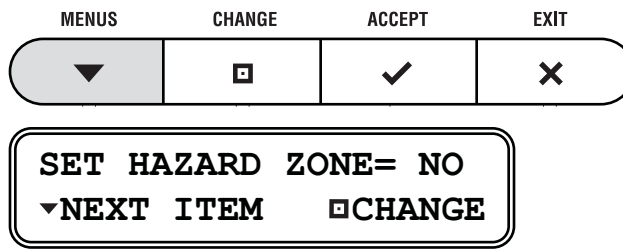

- Press □CHANGE until the display shows "SET HAZARD ZONE = YES."

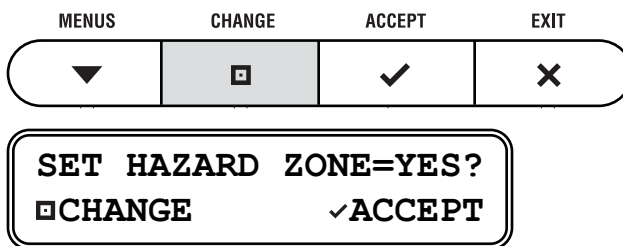

- Press ✓ACCEPT.

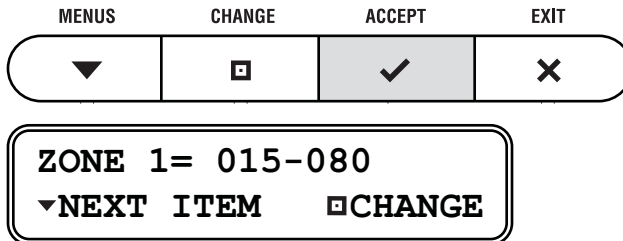

- Press ▼MENUS until the display shows "XMT IN ZONES."

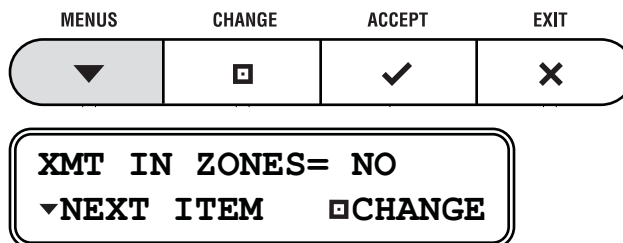

7. Press CHANGE until the display shows "XMT IN ZONES = YES."

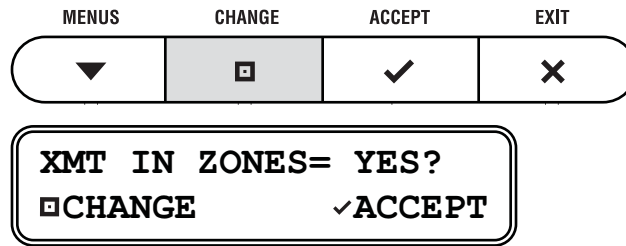

8. Press ACCEPT.

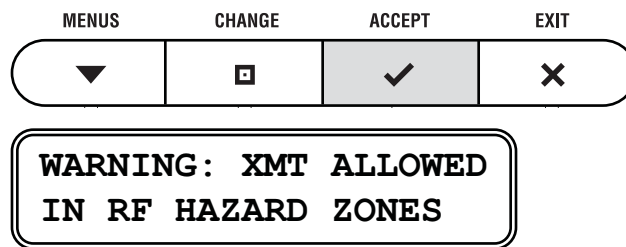

9. Press EXIT to exit the menu.



## Resetting the System to Factory Conditions

Follow the steps below to reset the TracPhone system to its original factory configuration.

	<b>CAUTION</b>
Resetting the system clears all RF radiation hazard zones. The antenna will be able to transmit in any direction until you reprogram the hazard zones into the antenna.	

1. Press ▼MENUS until the display shows "CONFIGURATION."

MENUS	CHANGE	ACCEPT	EXIT
▼	□	✓	✕

**CONFIGURATION**

▼NEXT MENU    ✓ACCEPT

2. Press ✓ACCEPT.

MENUS	CHANGE	ACCEPT	EXIT
▼	□	✓	✕

**BRIGHTNESS= HIGH**

▼NEXT ITEM    □CHANGE

3. Press ▼MENUS until the display shows "FACTORY RESET."

MENUS	CHANGE	ACCEPT	EXIT
▼	□	✓	✕

**FACTORY RESET= NO**

▼NEXT ITEM    □CHANGE

4. Press CHANGE until the display shows "FACTORY RESET= YES."

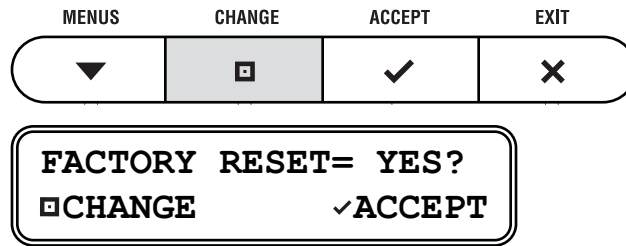

5. Press ACCEPT.

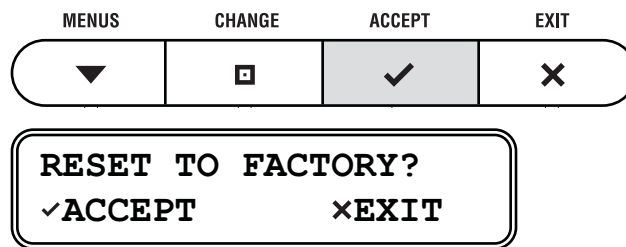

6. Press ACCEPT again to reset the system.

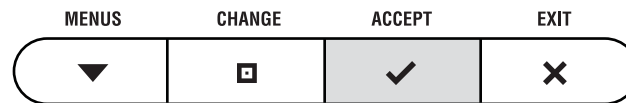

## Configuring Your Computer for mini-VSAT Broadband

Follow the steps below to configure your computer for DHCP addressing. This will allow your computer to communicate with the modem via its Ethernet connection.

***NOTE:** If you wish to set up a wireless connection, set up and test a wired Ethernet connection first. Then purchase a wireless access point (WAP), connect it to the switch, and follow the wireless setup instructions provided with the WAP.*

**IMPORTANT!**

If the system is installed on a steel vessel, setting up a wireless connection might require a special WAP and the services of a technician with advanced networking expertise.

**IMPORTANT!**

When setting up a wireless network, be sure to apply security settings, such as encryption, to protect your network from outside intrusion. If your network is not secure, outsiders within range of your wireless network will be able to use your wireless connection without your knowledge.

KVH Technical Support fully supports the four operating systems described here: Windows 7, Vista™, and XP, and Macintosh® OS X.

## Windows 7 or Vista

Follow the steps below to configure a Windows 7 or Vista computer.

1. From the Windows Control Panel, navigate to the **Network and Sharing Center**. *You can find the Control Panel either through the Start menu or "My Computer."*
2. At the Network and Sharing Center window, double-click the **Local Area Connection** link (Windows 7) or **View Status** link (Windows Vista) for the Ethernet connection you are using for mini-VSAT Broadband.

### Windows 7

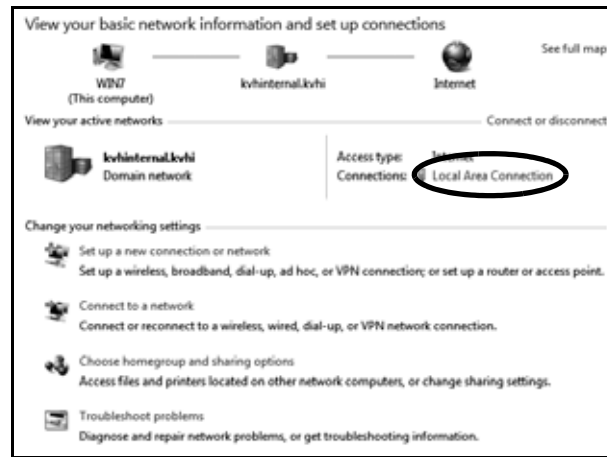

### Windows Vista

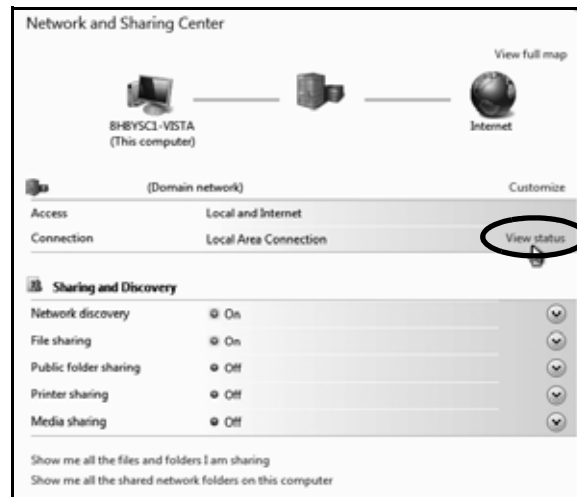

3. At the Local Area Connection Status window, click **Properties**. *If this screen doesn't appear, just skip to Step 4.*

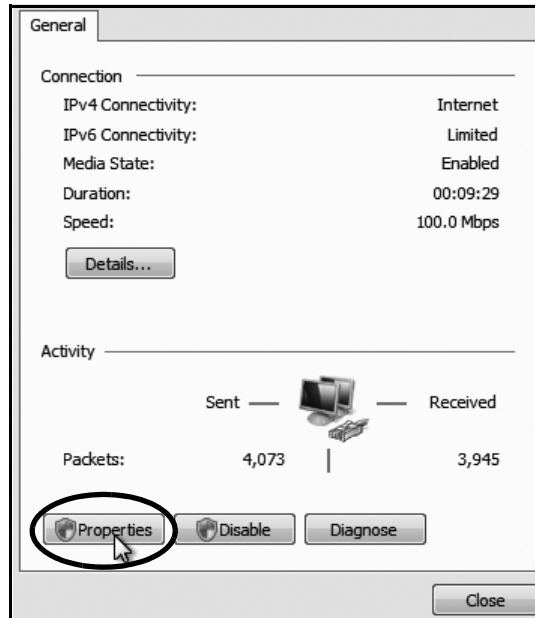

4. At the Local Area Connection Properties window, select the **Networking** tab. Then select **Internet Protocol Version 4** and click **Properties**.

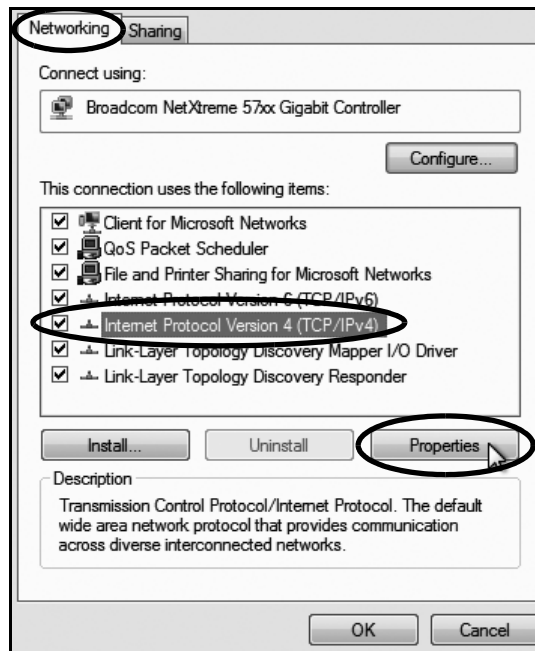

5. At the Internet Protocol Properties window, select **Obtain an IP address automatically** and **Obtain DNS server address automatically**. Then click **OK**.

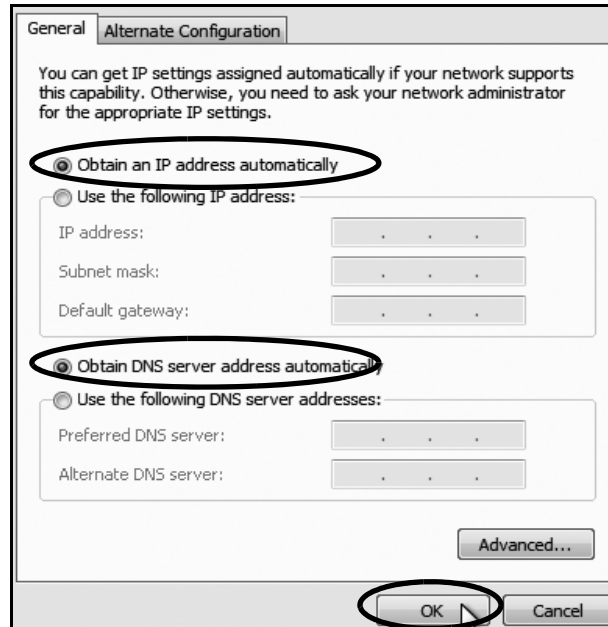

6. At Local Area Connection Properties, click **OK**.

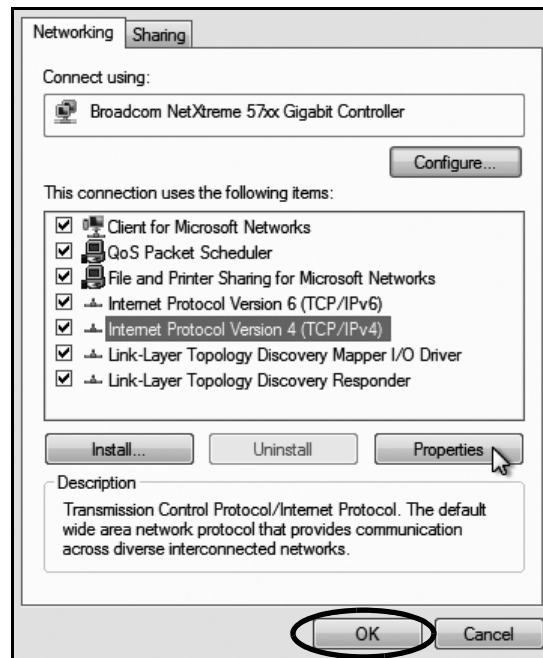



## Windows XP

Follow the steps below to configure a Windows XP computer.

1. At the Windows Control Panel, double-click the **Network Connections** icon. *You can find the Control Panel either through the Start menu or "My Computer."*
2. At the Network Connections window, double-click the **Local Area Connection** icon for the Ethernet connection you are using for mini-VSAT Broadband.

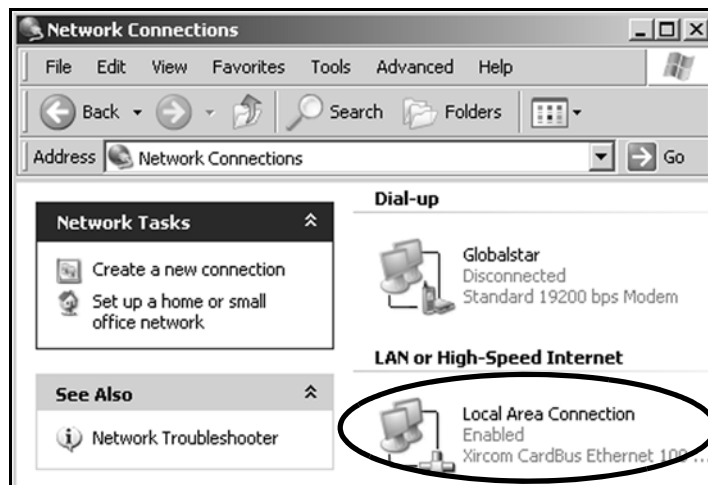

3. At the Local Area Connection Status window, select the General tab. Then click the **Properties** button. *If this screen doesn't appear, simply skip to Step 4.*

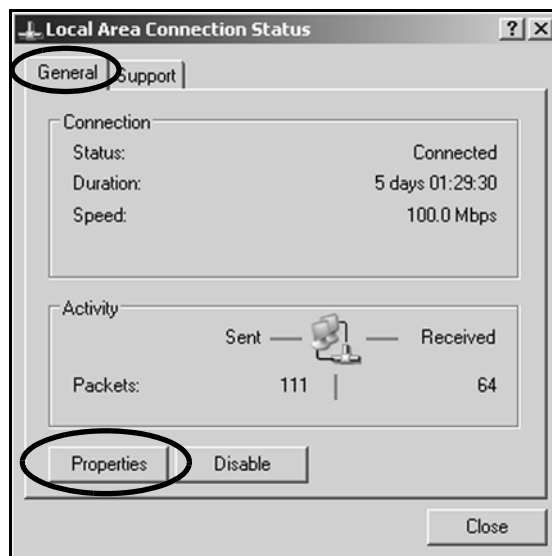

4. At the Local Area Connection Properties window, select the **General** tab. Then select **Internet Protocol (TCP/IP)** and click **Properties**.

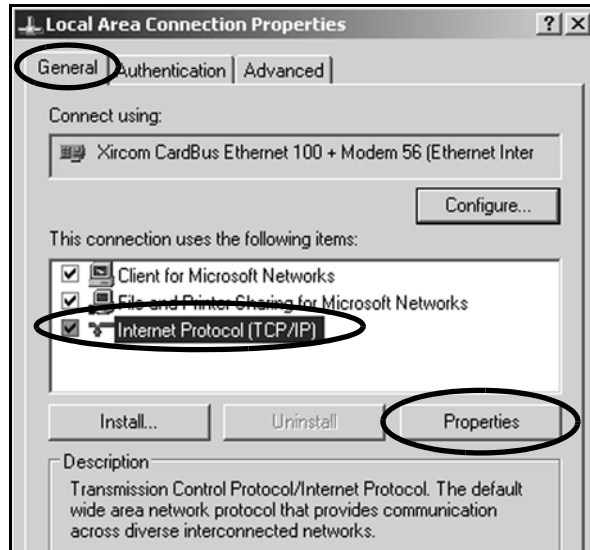

5. At the Internet Protocol (TCP/IP) Properties window, select the **General** tab. Then select **Obtain an IP address automatically** and **Obtain DNS server address automatically**. Then click **OK**.

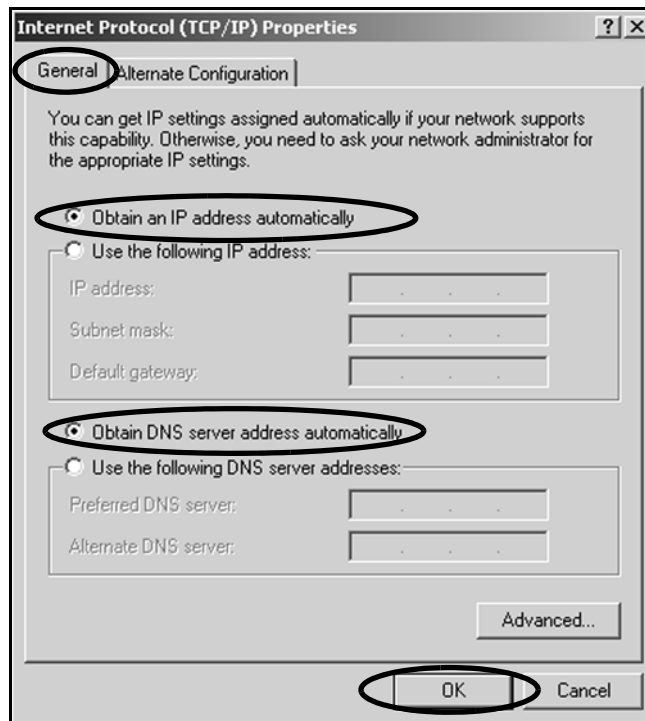

6. At Local Area Connection Properties, click **OK**.

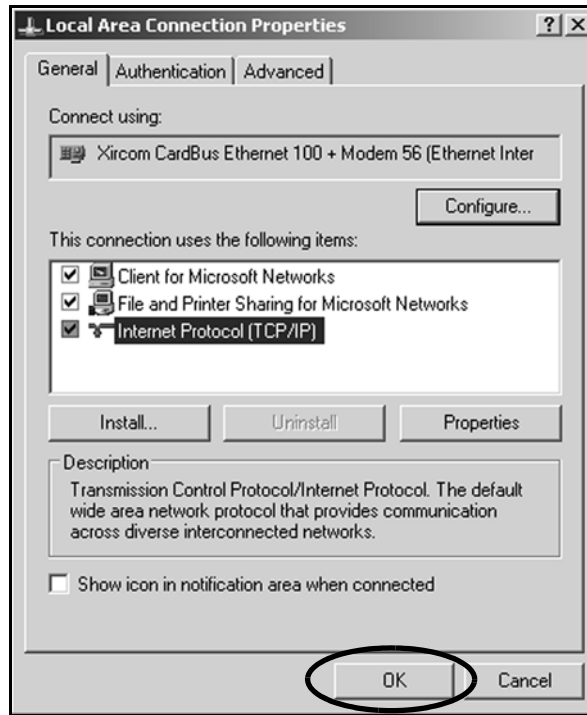

7. Restart your computer.

## Mac OS X

Follow the steps below to configure a Mac OS X computer.

1. At System Preferences, click the **Network** icon.
2. At the Network window, select the following:
  - Show: **Built-in Ethernet**
  - Configure: **Using DHCP**
  - Leave all text boxes blank

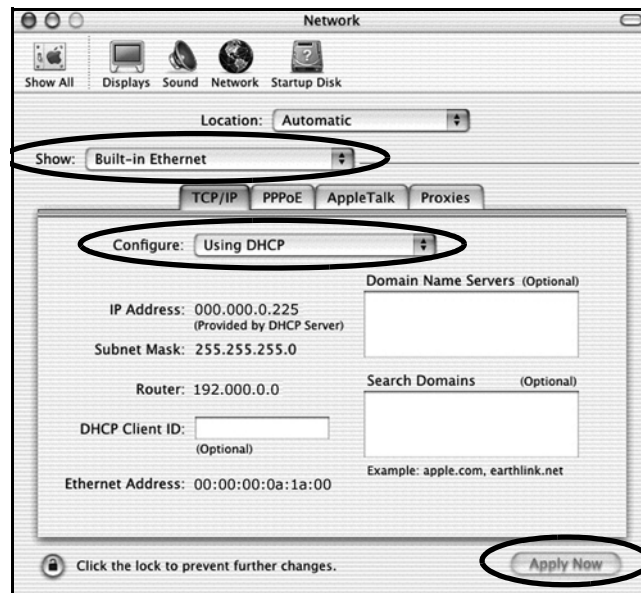

3. Click **Apply Now**.

## Requesting Static IP Addressing

At your request, KVH can enable static IP addressing for your TracPhone V3 system (*a fee will apply*). With a static IP address assigned to a computer system onboard your vessel, parties on shore will be able to access that computer directly over the Internet.

**IMPORTANT!**

A static IP address provides an open, unprotected connection to the Internet. Therefore, you should only assign a static IP address to a secure device, such as a firewall router.

To request a static IP address, just fill out the online form at [www.kvh.com/mvbservice](http://www.kvh.com/mvbservice). Be sure to read all of the details on this form.

Once your static IP address is established, KVH will send you an e-mail containing your new static IP information, along with instructions on configuring your onboard computer.



# 4. Troubleshooting

This chapter identifies basic problems along with their possible causes and solutions. It also explains what the status lights indicate, how to use the diagnostic functions, and how to get technical support.

## Contents

Five Simple Checks .....	47
Control Unit Status Lights.....	48
Modem Status Light .....	50
Error Messages .....	51
Troubleshooting a Voice Service Problem .....	56
Viewing Status Information on Your Web Browser.....	57
Viewing Status Information on the Control Unit.....	63
Calibrating the Antenna Gyros.....	70
Technical Support.....	72





## Five Simple Checks

If you are experiencing a problem with your TracPhone system, first check the five simple things below. If these checks do not lead you to the problem, contact KVH Technical Support for assistance (see [“Technical Support” on page 72](#)).

### Check #1: Are all lights on the control unit and modem lit green?

There are three status lights on the front panel of the control unit and one status light on the modem. If any of these lights are not lit green, see [“Control Unit Status Lights” on page 48](#) and [“Modem Status Light” on page 50](#) for failure indications.

### Check #2: Are any error messages displayed on the control panel?

If the control panel is showing an error message, see [“Error Messages” on page 51](#) for error definitions.

### Check #3: Can the antenna find the satellite?

If the antenna is continuously searching for the satellite, check the area around the antenna for blockage. The antenna needs an unobstructed view of the sky to receive satellite signals. Common causes of blockage include buildings, bridges, mountains, and onboard equipment or structures. You can determine which direction the antenna is pointing by viewing the “ANTENNA AZ/EL” status on the control unit; see [“Antenna Status Messages” on page 67](#). If there is no blockage, you might be located outside of the mini-VSAT Broadband service coverage area (for details, visit [www.kvh.com/minivsatmap](http://www.kvh.com/minivsatmap)).

### Check #4: Are all system components powered on and connected properly?

Make sure power is applied to all system components, including the modem, control unit, switch, and MTA. Also make sure all of the interconnecting cables are connected tightly.

### Check #5: If you can't connect via a wireless network, does a wired connection work?

If you have a wireless network onboard, but you are unable to connect to the Internet while the TracPhone system is online, connect your computer directly to the switch via a straight-through (not crossover) Ethernet cable, then restart your computer. If you can then access the Internet, there is a problem with your wireless network.

## Control Unit Status Lights

Three status lights on the front of the control unit indicate the current status of the system and can help you identify problems quickly.

Figure 4-1 Control Unit Status Lights

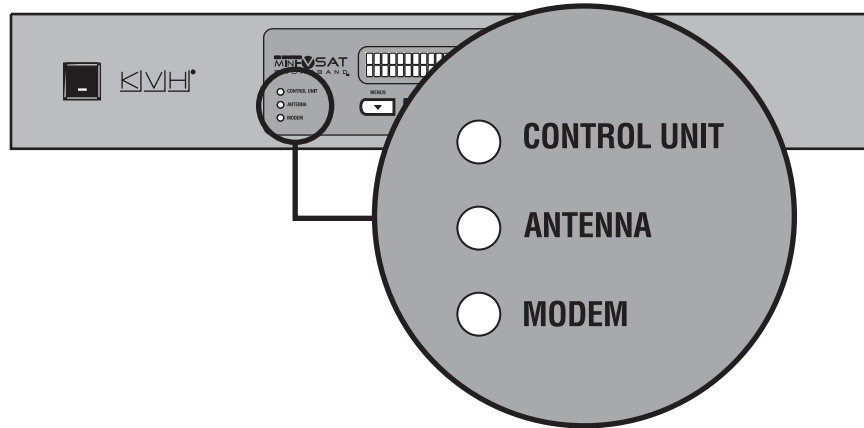

During normal operation, all three status lights should be lit green. The following tables explain what the different light conditions indicate.

### CONTROL UNIT Light

The table below explains what the CONTROL UNIT light indicates.

Light is...	Indicates	Description
Off	Off	Control unit is powered off or no power input
Green	OK	Good input power; control unit is operational
Orange	Bad power	Bad power supply circuit inside the control unit
Red	Fault	Error detected during control unit self test; try turning the control unit off, then back on



## ANTENNA Light

The table below explains what the ANTENNA light indicates.

<b>Light is...</b>	<b>Indicates</b>	<b>Description</b>
Off	Off	No power input to the antenna
Green	Tracking	Antenna is tracking a satellite
Green, flashing	Searching	Antenna is searching for a satellite, or the modem is initializing
Red	Fault	Error detected; see error message on display

## MODEM Light

The table below explains what the MODEM light indicates.

<b>Light is...</b>	<b>Indicates</b>	<b>Description</b>
Off	Off	Modem is powered off or initializing
Green	Online	Modem is online and logged into the mini-VSAT Broadband service
Green, flashing	Comms OK	Modem is communicating with the antenna, but it is not yet online
Orange	Fault	Error detected; see error message on display
Red	No comms	Control unit has lost communications with the modem; check wiring

## Modem Status Light

A status light on the front of the modem indicates the current status of the modem and can help you identify problems.

Figure 4-2 Modem Status Light

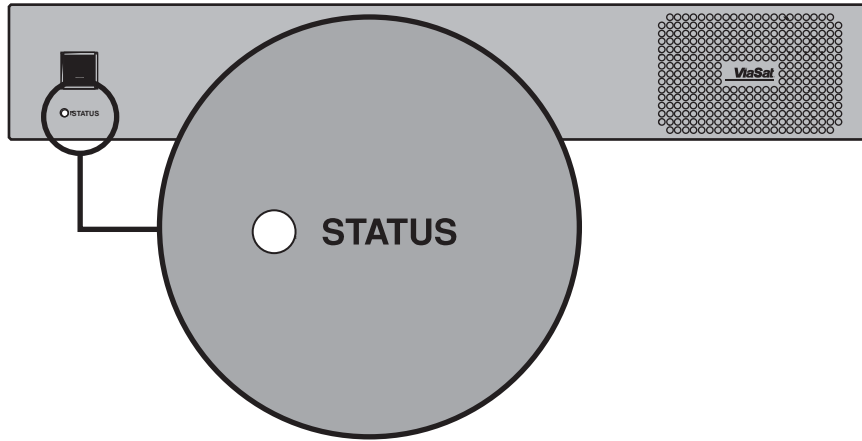

During normal operation, the status light should be lit green. The following table explains what the different light conditions indicate.

Light is...	Indicates	Description
Off	Off	Modem is powered off or initializing
Green	Online	Modem is logged into the mini-VSAT Broadband network
Green, flashing	Transmitting	Modem is transmitting data or logging into the mini-VSAT Broadband network
Orange, flashing	Logging In	Modem is logging into the mini-VSAT Broadband network
Red	Searching or Fault	Antenna is searching for the service satellite, or error detected in modem; if antenna is tracking the service satellite, try turning the modem off, then back on

## Error Messages

The table below lists error messages that might appear on the control unit display to indicate a system problem. Many of these faults should only be repaired by a KVH-certified technician; contact KVH Technical Support for assistance (see [“Technical Support”](#) on page 72).

Error Message	Description
<div style="border: 1px solid black; border-radius: 10px; padding: 5px; text-align: center;">                     CABLE UNWRAP PLEASE WAIT                 </div>	The antenna is unwrapping its internal cable; wait 30 seconds.
<div style="border: 1px solid black; border-radius: 10px; padding: 5px; text-align: center;">                     ERROR: ANTENNA AZ ASSEMBLY                 </div>	The antenna's azimuth motor or limit switch failed. Contact KVH Technical Support.
<div style="border: 1px solid black; border-radius: 10px; padding: 5px; text-align: center;">                     ERROR: ANTENNA COMM FAILURE                 </div>	The control unit has lost communications with the antenna. Check the wiring and try turning the control unit and modem off, then back on. If the error persists, contact KVH Technical Support.
<div style="border: 1px solid black; border-radius: 10px; padding: 5px; text-align: center;">                     ERROR: ANTENNA EL ASSEMBLY                 </div>	The antenna's elevation motor or limit switch failed. Contact KVH Technical Support.
<div style="border: 1px solid black; border-radius: 10px; padding: 5px; text-align: center;">                     ERROR: ANTENNA OVERTEMP                 </div>	The antenna is disabled because its temperature has risen above 85°C. Turn off the system and allow it to cool down.
<div style="border: 1px solid black; border-radius: 10px; padding: 5px; text-align: center;">                     ERROR: ANTENNA POWER OPEN                 </div>	There is an open circuit in the antenna power/data cable. Check the cable.
<div style="border: 1px solid black; border-radius: 10px; padding: 5px; text-align: center;">                     ERROR: ANTENNA POWER SHORT                 </div>	There is a short circuit in the antenna power/data cable. Check the cable.
<div style="border: 1px solid black; border-radius: 10px; padding: 5px; text-align: center;">                     ERROR: ANTENNA POWER SUPPLY                 </div>	The antenna's power supply circuit might have failed. Contact KVH Technical Support.
<div style="border: 1px solid black; border-radius: 10px; padding: 5px; text-align: center;">                     ERROR: ANTENNA SKEW ASSMBLY                 </div>	The antenna's skew motor or limit switch failed. Contact KVH Technical Support.

Error Message	Description
<p><b>ERROR:</b>  <b>BUC POWER OPEN</b></p>	<p>There is an open circuit in the BUC power cable (between the control unit and the modem) or the transmit (TX) RF cable. Check the cables.</p>
<p><b>ERROR:</b>  <b>BUC POWER SHORT</b></p>	<p>There is a short circuit in the BUC power cable (between the control unit and the modem) or the transmit (TX) RF cable. Check the cables.</p>
<p><b>ERROR:</b>  <b>CTRL UNIT OVERTEMP</b></p>	<p>The control unit has stopped supplying antenna and BUC power because its temperature has risen above 85°C. Turn off the system and allow it to cool down. You might need to relocate the unit to an area that provides better ventilation.</p>
<p><b>ERROR:</b>  <b>CTRL UNIT PWR SUPPLY</b></p>	<p>The control unit is not supplying enough power to the antenna. Contact KVH Technical Support.</p>
<p><b>ERROR:</b>  <b>GPS FAILURE</b></p>	<p>The GPS is not communicating with the control unit. Try turning the control unit off, then back on. Also, check the terminal strip wiring at the control unit's rear panel. If the error persists, the GPS module inside the antenna might need to be replaced. Contact KVH Technical Support.</p>
<p><b>ERROR:</b>  <b>GYRO BIAS ERROR</b></p>	<p>One of the antenna's gyros is out of calibration. Try recalibrating the gyros (see "<a href="#">Calibrating the Antenna Gyros</a>" on page 70). If a gyro fails to calibrate, contact KVH Technical Support. The gyro might need to be replaced.</p>

Error Message	Description
<p><b>ERROR: MODEM COMM FAILURE</b></p>	<p>The control unit has lost communications with the modem. Ensure the modem is powered on and check the interconnecting cables. You can also try turning the modem off, then back on. If the error persists, contact KVH Technical Support.</p>
<p><b>ERROR: MODEM RSSI FAILURE</b></p>	<p>The modem is not providing satellite signal strength data to the control unit. Try turning the modem off, then back on. If the error persists, contact KVH Technical Support.</p>
<p><b>ERROR: NO LNB POWER</b></p>	<p>The antenna's LNB (low noise block) is not receiving 12-18 VDC from the modem's "Rx RF" port. Ensure the modem is turned on and check the RX RF cable.</p>
<p><b>ERROR: RF RSSI FAILURE</b></p>	<p>The control unit is not forwarding satellite signal strength data to the antenna. Try turning the control unit and modem off, then back on. If the error persists, contact KVH Technical Support.</p>
<p><b>ERROR: RF SOFTWARE FAILURE</b></p>	<p>The antenna's RF software might be corrupted. Check the wiring and try turning the control unit and modem off, then back on. If the error persists, contact KVH Technical Support.</p>
<p><b>OFFLINE OUTSIDE COVERAGE</b></p>	<p>Your vessel is located outside the mini-VSAT Broadband coverage area, where service is unavailable (or you are located within a governmentally restricted area). Service will be restored once you reenter the coverage area.</p>

Error Message	Description
<div style="border: 1px solid black; border-radius: 10px; padding: 5px; text-align: center;"> <b>RF RADIATION HAZARD!            TRANSMIT INHIBITED</b> </div>	<p>The antenna is pointing within one of your programmed RF radiation hazard zones. See <a href="#">“Configuring RF Radiation Hazard Zones”</a> on page 25 for details.</p>
<div style="border: 1px solid black; border-radius: 10px; padding: 5px; text-align: center;"> <b>TRANSMIT INHIBITED            BY CTRL UNIT</b> </div>	<p>The transmitter is temporarily disabled due to severe sea conditions or excessive vibration.</p>
<div style="border: 1px solid black; border-radius: 10px; padding: 5px; text-align: center;"> <b>WAITING FOR GPS</b> </div>	<p>The system is not yet receiving valid position data from the GPS. It might take several minutes for the GPS to acquire a fix. If this message does not clear, check for antenna blockage and make sure the antenna’s radome is clear of grime. Also check for nearby radio antennas or radars, whose RF energy might interfere with GPS reception. You can also try turning the control unit off, then back on.</p>
<div style="border: 1px solid black; border-radius: 10px; padding: 5px; text-align: center;"> <b>WARNING:            MODEM LAN LINK DOWN</b> </div>	<p>The modem does not detect a local area network (LAN) on its “User Enet” port. Make sure the switch is connected to the modem via a straight-through, not crossover, cable.</p>
<div style="border: 1px solid black; border-radius: 10px; padding: 5px; text-align: center;"> <b>WARNING:            MODEM OVERTEMP</b> </div>	<p>The modem is disabled because its temperature has risen above 85°C. Listen for the cooling fan inside the modem. If you don’t hear the fan, contact KVH Technical Support. If you hear the fan, turn off the system, allow it to cool down, and vacuum the modem’s vents. You might also need to relocate the unit to an area that provides better ventilation.</p>



Error Message	Description
<p data-bbox="500 327 881 411"><b>WARNING :</b> <b>NO SERVICE SAT INFO</b></p>	<p data-bbox="922 317 1364 600">The modem is communicating OK with the control unit, but it is not providing any data to identify the service satellite. Wait a few minutes, then try turning the modem off, then back on. If the warning persists, contact KVH Technical Support.</p>
<p data-bbox="500 653 881 737"><b>WARNING :</b> <b>OUTSIDE COVERAGE</b></p>	<p data-bbox="922 642 1360 884">Your vessel is located outside the mini-VSAT Broadband coverage area, where service is unavailable (or you are located within a governmentally restricted area). Service will be restored once you reenter the coverage area.</p>

## Troubleshooting a Voice Service Problem

If you can access the Internet via the TracPhone system, but you are unable to make a voice call, try the five simple steps below.

### Step #1: Make Sure You Are Dialing the Number Properly

As explained in [“Placing a Voice Call” on page 16](#), if you are not calling the country that is currently set up as the MTA's dial plan, you need to dial the appropriate international prefix(es) in addition to the local phone number in order to complete the connection. For example, if your MTA is set to a United States dial plan (*default setting*) and you are calling a number outside of the U.S., you need to dial 011 + Country Code + Area Code + Local Phone Number.

### Step #2: Reboot the MTA

The MTA might need to download an updated configuration file from the network. Unplug the power cord from the MTA. Wait 10 seconds, then plug it back in and wait for the device to initialize (it may take 15 minutes for the MTA to download the configuration file). Once the MTA's “VOIP” light is lit steady green, try placing your call again.

### Step #3: Verify the MTA Obtained an IP Address

The MTA must receive an IP address from the modem in order to provide a voice connection. Pick up the handset on any phone connected to the MTA and press **\*\*\*1** on the keypad. If you hear “0.0.0.0” in the handset, the MTA did not receive a valid IP address. Contact KVH Technical Support for assistance (see [“Technical Support” on page 72](#)).

### Step #4: Connect a Different Phone

Disconnect the phone from the MTA and connect another phone in its place (use a phone that you know is working properly). If you are then able to place a call with the new phone, the phone you were using is faulty.

### Step #5: Verify the Phone Is Connected Properly

Make sure your phone is connected to the RJ11 “PHONE 1” jack on the MTA (not the “PHONE 2” jack). Also verify that the MTA is connected to vessel AC power and all system wiring is correct.



## Viewing Status Information on Your Web Browser

Complete system status information is available via the modem's local web interface. Simply open the web browser on any networked computer and enter the following web address:

**http://192.168.0.1**

As long as the modem is connected and functioning properly, the General Status page will display in your browser.

Figure 4-3 General Status Page on Modem Web Interface

General Status			
<b>LOGIN</b>			
Terminal ID	4.217		
Login State	Logged In	State	Transmit Enabled
Login State Time	0d:6h:31m:15s	Last Login	Wed Apr 7 05:29:40 2010 GMT
Terminal Uptime	0d:6h:39m:30s	Attempted Logins	0
Successful Logins	1	Time	Wed Apr 7 12:00:56 2010 GMT
BB Messages Rx	4832	System Time	Wed Apr 7 12:00:56 2010 GMT
ETI	33d:23h:0m:0s	Serial Number	0x00000000
Software Version	3212		
<b>FORWARD LINK</b>			
Eb/No	5.44 dB	FL State	Locked <input checked="" type="radio"/>
Amplitude	24.45 dB	AGC	0x02566177
IP Packets Rx	43498		
FLR Packets Rx	11204		
Dropped (CRC)	267		
<b>RETURN LINK</b>			
Tx Disable	Off <input type="radio"/>	Doppler Frequency	0 Hz
Data Rate	128000 bps	Attenuation	20.60 dB
IP Packets Tx	8422	Default Attenuation	16.00 dB
Tx Disable Count	10	Attenuation Limit	5.00 dB
Tx Disable Time	0d:0h:58m:55s	Total Attenuation	20.60 dB
<b>POSITIONAL</b>			
Latitude	41.51°	Satellite Longitude	-125°
Longitude	-71.28°	Satellite Handoff Status	Handoff satellite available
Altitude	0 ft	Satellite Handoff Distance	39 mi
Velocity	0 knots	ATI Distance	1023 mi
<b>HARDWARE</b>			
ACU State	Online Tx	ACU Status	<input checked="" type="radio"/> <input type="radio"/> <input type="radio"/> <input type="radio"/> <input type="radio"/> <input type="radio"/> <input type="radio"/> <input type="radio"/> <input type="radio"/> <input type="radio"/> <input type="radio"/>
TXR Temperature	36 °C	TXR Boots	150
Chassis Temperature	30 °C	TXR Fan Speed	2670 rpm

## General Status: Login

The Login section provides the following helpful information:

Status Field	Description
Terminal ID	Last two octets of the modem's external satellite IP address: <b>10.61.x.x</b> ; its identity on the mini-VSAT Broadband network
Login State	Status of the network login: <ul style="list-style-type: none"> <li>• Logged In - Modem is logged into the network</li> <li>• Logged out - Modem is logged out of the network; no user traffic will pass</li> <li>• Waiting - Modem is attempting to log in; waiting for hub reply</li> </ul>
State	Modem's operating state; should be "Transmit Enabled" while the antenna is tracking the service satellite
Login State Time (days:hours:minutes:seconds)	Duration of the current Login State
Last Login	Date/time of the modem's last successful login to the network
Terminal Uptime (days:hours:minutes:seconds)	Length of time the modem has been in operation*
Attempted Logins	Number of times the modem has attempted to log into the network*
Successful Logins	Number of times the modem has logged into the network*
BB Messages Rx	Number of bulletin board messages received from the hub*; should continuously increment while logged in
Serial Number	Modem serial number
Software Version	Modem software version

\* Since the modem's last restart

## General Status: Forward Link

“Forward Link” refers to the communications path from the service hub to your vessel (downloads). The Forward Link section provides the following helpful information:

Status Field	Description
Eb/No	Quality of the received signal; should be at least 2 dB; “No Lock” indicates satellite blockage or the antenna is searching for a satellite
FL State	Should be “Locked” and green while the modem is logged in
FLR Packets Rx	Number of data packets received; should continuously increment while logged in
Dropped (CRC)	Dropped data packets due to errors; should not increment in large numbers

## General Status: Return Link

“Return Link” refers to the communications path from your vessel to the service hub (uploads). The Return Link section provides the following helpful information:

Status Field	Description
Tx Disable	Should be “Off” and green while tracking the service satellite, “On” and red when pointing within a configured RF hazard zone
Data Rate	Rate at which the modem is <b>capable</b> of transmitting data; does not indicate the actual data rate supported by your service plan
Attenuation	Set by the hub; the lower the number, the higher your antenna’s transmission power; typically between 5-32 dB
IP Packets Tx	Number of data packets transmitted by the modem

## General Status: Positional

The Positional section provides the following helpful information:

Status Field	Description
Latitude, Longitude	Your vessel's position, reported by the antenna's GPS
Satellite Longitude	Longitude (orbital slot) of the current service satellite
Satellite Handoff Status	Availability of an adjacent satellite for continued coverage: <ul style="list-style-type: none"> <li>• Handoff satellite available - At your vessel's position, another satellite's coverage area (footprint) overlaps your current satellite's footprint</li> <li>• No satellite available - There are no adjacent satellites; coverage will be lost once you travel outside the current satellite's footprint</li> </ul>
Satellite Handoff Distance	Number of miles between your vessel's position and the nearest boundary of your current satellite's footprint ( <i>this boundary might not be located along your direction of travel</i> )



## General Status: Hardware

The Hardware section provides the following helpful information:

Status Field	Description
ACU State	Status of the antenna/control unit (ACU): <ul style="list-style-type: none"> <li>• Offline - Antenna/control unit is not communicating with the modem</li> <li>• Signal Acquisition - Antenna is searching for the satellite</li> <li>• Online Tx Inhibit - Antenna is tracking the service satellite, but inhibited from transmitting due to either an RF hazard zone or location in a restricted area</li> <li>• Online Tx - Antenna is tracking the service satellite and allowed to transmit</li> </ul>
ACU Status	Health monitor of the antenna/control unit; all LEDs should be green; if any LED is red, mouse over it to identify the fault
Chassis Temperature	Internal temperature of the modem's chassis (in °C)
TXR Fan Speed	Current rotational speed (rpm) of the modem's cooling fan; 0 rpm indicates a fan failure

## Antenna and Control Unit Serial Numbers

While the modem's serial number is provided on the General Status page, the serial numbers for the antenna and control unit (ACU) can be found on the ACU Status page (click the "ACU/Antenna" link in the sidebar).

Figure 4-4 ACU Status Page

ACU Status			
<div style="text-align: left;"> <span>▾ ACU</span> </div>			
State	Online Tx	Alarm Status	
Uptime	0d:8h:26m:9s	ACU POST Status	
ETI	0d:0h:0m:0s	Aircraft Type	Gulfstream G500
Temperature	43 °C	Hardware Part #	V3
Type	Serial 0 (TRACSTAR/KVH)	Hardware Serial #	000000000
HPA Power	On	Software Part #	10
Nav Data Ch1 Good	25012	Software Version	4.21
Nav Data Ch1 Bad	0	Software Status	Not updating
Nav Data Ch2 Good	0	Calculated Heading	0°
Nav Data Ch2 Bad	0	Calculated Roll Rate	0 °/s
IP Address	192.168.0.2	Calculated Pitch Rate	0 °/s
IP Address Mask	255.255.255.0	Port	7915
Link Rate	1 Hz	Gateway IP Address	127.0.0.1
Tracking State	Homing	RSSI Rate	60 Hz
<div style="text-align: left;"> <span>▾ ANTENNA</span> </div>			
Temperature	0 °C	Type	KVH
Platform Roll Offset	0°	ETI	0d:0h:0m:0s
Platform Pitch Offset	0°	Calibration	Not calibrating
Platform Yaw Offset	0°	Sensors	
GIV Flap Code	0	Slip Detection	
Flap 1 Offset	0°	LNB Select	11.7 to 12.2 GHz
Flap 2 Offset	0°	Part #	2.22
Flap 3 Offset	0°	Serial #	999999999
Flap 4 Offset	0°	Antenna Mount Orientation	Facing tail
Azimuth Error Limit	5°	Horiz. Stabilizer Pos.	0
Polarization Error Limit	5°	Elevation Error Limit	5°
		Flap Positions (Discretes)	

**NOTE:** The General Status page provides all of the status information you might need to know, other than the two serial numbers noted above. All other status pages provide very detailed and advanced information that only KVH Technical Support might use for troubleshooting.

## Viewing Status Information on the Control Unit

If you are unable to view the status information screens on the modem's web interface, you can also view system status information on the control unit's display. You can select either modem or antenna status information from the main menu.

### Modem Status Information

1. Press ▼MENUS until the display shows "MODEM STATUS."

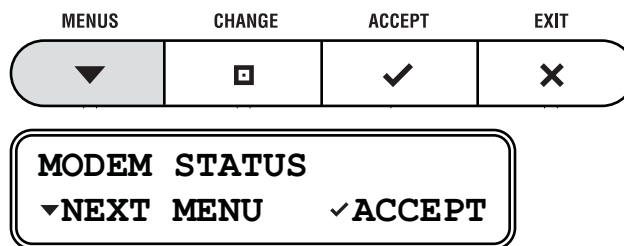

2. Press ✓ACCEPT to start viewing the modem status screens.

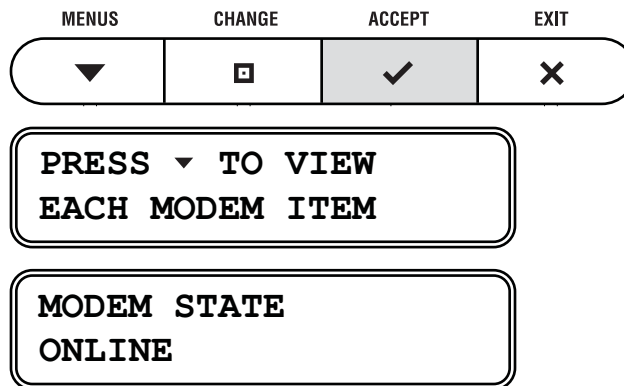

3. Press ▼MENUS to scroll forward through the status messages. Press □CHANGE to scroll backward. When you are done reviewing status messages, press ✕EXIT.

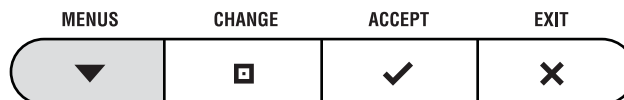

## Modem Status Messages

The table below lists all of the modem status messages.

Status Message	Description
<div style="border: 1px solid black; border-radius: 10px; padding: 5px; width: fit-content;"> <b>MODEM STATE ONLINE</b> </div>	General status of the modem: <ul style="list-style-type: none"> <li>• Online - Modem is connected to the mini-VSAT Broadband service</li> <li>• Offline - Modem is not connected to the service</li> <li>• Initializing</li> <li>• Attempting Login</li> <li>• Waiting for Hub Comm</li> <li>• Transmit Disabled</li> </ul>
<div style="border: 1px solid black; border-radius: 10px; padding: 5px; width: fit-content;"> <b>ETHERNET LAN STATUS LINK OK</b> </div>	Status of the Ethernet local area network (LAN) connection: <ul style="list-style-type: none"> <li>• Link OK</li> <li>• Link Down</li> </ul>
<div style="border: 1px solid black; border-radius: 10px; padding: 5px; width: fit-content;"> <b>SERVICE SATELLITE 72.5W</b> </div>	Satellite currently selected for mini-VSAT Broadband service
<div style="border: 1px solid black; border-radius: 10px; padding: 5px; width: fit-content;"> <b>DOWNLINK FREQUENCY 11.840 GHZ</b> </div>	Frequency of the satellite downlink (in GHz)
<div style="border: 1px solid black; border-radius: 10px; padding: 5px; width: fit-content;"> <b>DOWNLNK POLARIZATION HORIZONTAL</b> </div>	Polarization of the satellite downlink: <ul style="list-style-type: none"> <li>• Horizontal Linear</li> <li>• Vertical Linear</li> </ul>
<div style="border: 1px solid black; border-radius: 10px; padding: 5px; width: fit-content;"> <b>EB/NO 08.6 dB</b> </div>	Quality of the received signal; Eb/No = Energy per bit/noise power per Hertz; must be greater than 2 dB for operation
<div style="border: 1px solid black; border-radius: 10px; padding: 5px; width: fit-content;"> <b>MODEM SATELLITE IP 10.61.4.9</b> </div>	External IP address of the modem; identity of the modem on the mini-VSAT Broadband network (10.61.4.0 - 10.61.7.255)



Status Message	Description
<div style="border: 1px solid black; border-radius: 10px; padding: 5px; width: fit-content;">                     MODEM LAN IP                      192.168.0.1                 </div>	Local IP address of the modem on the vessel's LAN
<div style="border: 1px solid black; border-radius: 10px; padding: 5px; width: fit-content;">                     MODEM SUBNET MASK                      255.255.255.0                 </div>	Subnet mask of the vessel's LAN that is connected to the modem
<div style="border: 1px solid black; border-radius: 10px; padding: 5px; width: fit-content;">                     MODEM DHCP STATUS                      ENABLED                 </div>	Status of the modem's DHCP server: <ul style="list-style-type: none"> <li>• Enabled - Modem is assigning IP addresses to clients on the LAN</li> <li>• Disabled - IP addresses must be assigned manually to each client on the LAN</li> </ul>
<div style="border: 1px solid black; border-radius: 10px; padding: 5px; width: fit-content;">                     MODEM TEMPERATURE                      50C                 </div>	Temperature of the modem chassis
<div style="border: 1px solid black; border-radius: 10px; padding: 5px; width: fit-content;">                     MODEM SERIAL #                      4:63                 </div>	Modem serial number
<div style="border: 1px solid black; border-radius: 10px; padding: 5px; width: fit-content;">                     MODEM SW VERSION                      3214                 </div>	Modem software version

## Antenna Status Information

1. Press ▼MENUS until the display shows "ANTENNA STATUS."

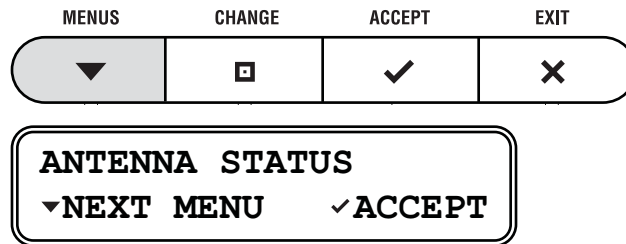

2. Press ✓ACCEPT to start viewing the antenna status screens.

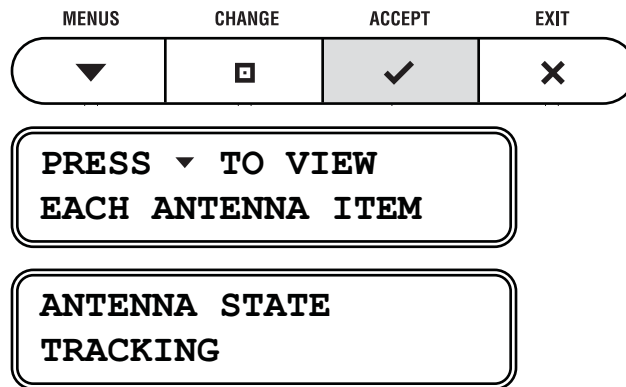

3. Press ▼MENUS to scroll forward through the status messages. Press □CHANGE to scroll backward. When you are done reviewing status messages, press ✕EXIT.

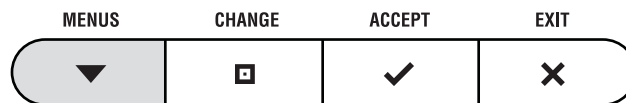

## Antenna Status Messages

The table below lists all of the status messages.

Status Message	Description
<b>ANTENNA STATE TRACKING</b>	General status of the antenna: <ul style="list-style-type: none"> <li>• Tracking</li> <li>• Searching</li> <li>• Initializing</li> <li>• Waiting for Modem</li> <li>• Cable Unwrap - Unwrapping the internal cable; the cable can wrap up to 720°</li> <li>• Idle</li> <li>• Error</li> </ul>
<b>CURRENT SATELLITE 72.5W</b>	Satellite that the modem has currently selected for tracking
<b>ANTENNA AZ/EL AZ:229.1, EL:79.8</b>	Azimuth and elevation at which the antenna is currently pointing, relative to the antenna's "Forward" arrow (bow)
<b>ANTENNA SKEW -68.4</b>	Current skew angle of the antenna's LNB
<b>TRUE HEADING NOT AVAILABLE</b>	Not applicable to TracPhone V3 systems
<b>GPS STATUS 41.5198N, 123.5817W</b>	Status of the antenna's GPS: <ul style="list-style-type: none"> <li>• Position data - Latitude/longitude reported by the GPS</li> <li>• Acquiring</li> <li>• Comm Failure</li> </ul>
<b>RF HAZARD ZONE 1 335-025</b>	Current setting for RF hazard zone #1
<b>RF HAZARD ZONE 2 225-265</b>	Current setting for RF hazard zone #2

Status Message	Description
<div style="border: 1px solid black; border-radius: 10px; padding: 5px; width: fit-content;"> <b>XMT IN ZONES</b>  NO </div>	Current setting for XMT in Zones: <ul style="list-style-type: none"> <li>• No - Transmission is inhibited if antenna points within a zone</li> <li>• Yes - Transmission unrestricted</li> </ul>
<div style="border: 1px solid black; border-radius: 10px; padding: 5px; width: fit-content;"> <b>ANTENNA DC INPUT</b>  41.2 VDC </div>	DC voltage measured at the antenna's circuit board; should be greater than 39 VDC
<div style="border: 1px solid black; border-radius: 10px; padding: 5px; width: fit-content;"> <b>CTRL UNIT DC INPUT</b>  13.4 VDC </div>	DC voltage measured at the control unit's power input; should be greater than 12.5 VDC
<div style="border: 1px solid black; border-radius: 10px; padding: 5px; width: fit-content;"> <b>BUC POWER ON</b>  21.4 VDC </div>	Status of the antenna's BUC (transmit) power: <ul style="list-style-type: none"> <li>• On - BUC power is applied; also reports actual measured power</li> <li>• Off - BUC power is disabled</li> </ul> Should be greater than 20 VDC
<div style="border: 1px solid black; border-radius: 10px; padding: 5px; width: fit-content;"> <b>ANTENNA MODEL</b>  TRACPHONE V3 </div>	Antenna model
<div style="border: 1px solid black; border-radius: 10px; padding: 5px; width: fit-content;"> <b>ANTENNA SERIAL #</b>  070901234 </div>	Antenna serial number
<div style="border: 1px solid black; border-radius: 10px; padding: 5px; width: fit-content;"> <b>ANTENNA MAIN BOARD</b>  SW VERSION 2.34 </div>	Main software version
<div style="border: 1px solid black; border-radius: 10px; padding: 5px; width: fit-content;"> <b>ANTENNA RF BOARD</b>  SW VERSION 1.23 </div>	RF software version
<div style="border: 1px solid black; border-radius: 10px; padding: 5px; width: fit-content;"> <b>ANTENNA AZ/EL MOTOR</b>  SW VERSION 1.28 </div>	Azimuth/elevation motor software version
<div style="border: 1px solid black; border-radius: 10px; padding: 5px; width: fit-content;"> <b>ANTENNA SKEW MOTOR</b>  SW VERSION 1.04 </div>	Skew motor software version
<div style="border: 1px solid black; border-radius: 10px; padding: 5px; width: fit-content;"> <b>CTRL UNIT SERIAL #</b>  070902147 </div>	Control unit serial number



<b>Status Message</b>	<b>Description</b>
<div data-bbox="500 323 873 411" style="border: 1px solid black; border-radius: 10px; padding: 5px; text-align: center;">CTRL UNIT SW VERSION 2.14</div>	Control unit software version

## Calibrating the Antenna Gyros

The TracPhone antenna's gyros continuously measure the motion of your vessel and send this data to the antenna's motor control circuitry to keep the antenna pointed at the satellite. At the factory, each antenna gyro is precisely calibrated to work with the antenna's circuit board. Therefore, if you ever have a gyro or circuit board replaced, you will need to recalibrate the gyros for the new part.

**IMPORTANT!**

Calibrate the gyros only if directed by KVH Technical Support, and only while the vessel is stationary. A poor gyro calibration can reduce the performance of the antenna.

Follow the steps below to calibrate the gyros.

1. Press ▼MENUMS until the display shows "DIAGNOSTICS."

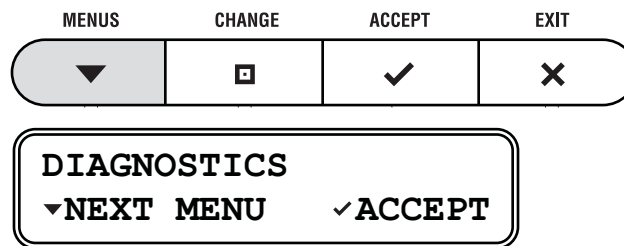

2. Press ✓ACCEPT to enter the Diagnostics menu.

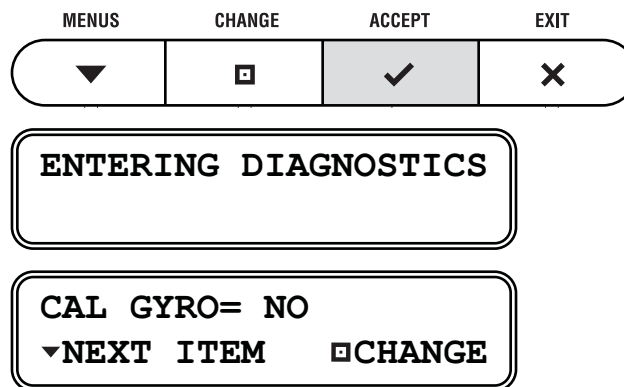

- Press **▣**CHANGE until the display shows “CAL GYRO= YES.”

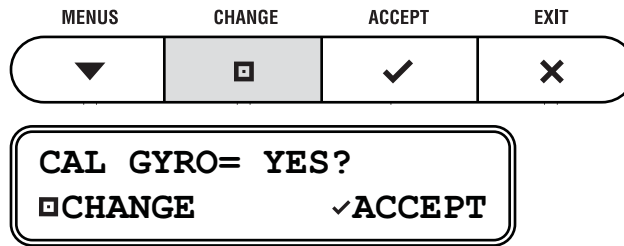

- Press **✓**ACCEPT to start gyro calibration.

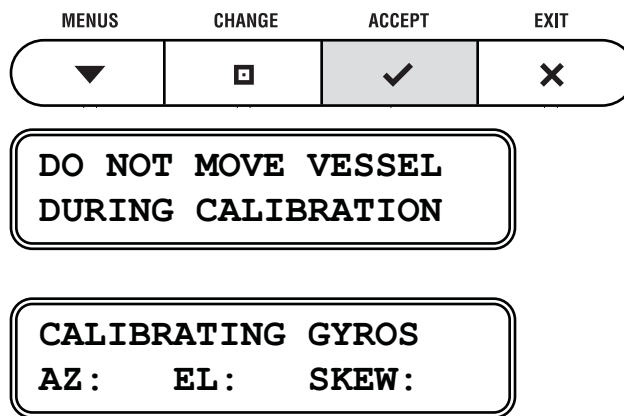

- Verify that the azimuth (AZ), elevation (EL), and skew gyros all pass (“P”). If any gyro fails (“F”), retry the calibration. If it continues to fail, please seek technical support (see [“Technical Support” on page 72](#)).

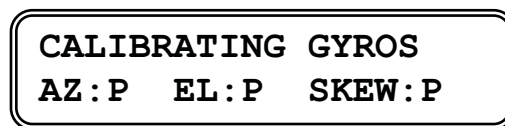

- Once the gyros are calibrated, the antenna restarts. Wait five minutes for system startup.

## Technical Support

The TracPhone V3 system is a sophisticated electronic device; only specially trained KVH-certified technicians have the tools and expertise necessary to diagnose and repair a system fault. Therefore, if you experience an operating problem or require technical assistance, please contact KVH Technical Support (24/7):

**Within the Continental U.S.A.:**

Phone: 1 866 701-7103 (via landline)

E-mail: [mvbsupport@kvh.com](mailto:mvbsupport@kvh.com)

**North/South America, Australia:**

Phone: +1 401 851-3806

E-mail: [mvbsupport@kvh.com](mailto:mvbsupport@kvh.com)

**Europe, Middle East, Asia, Africa:**

Phone: +45 45 160 180

E-mail: [support@kvh.dk](mailto:support@kvh.dk)

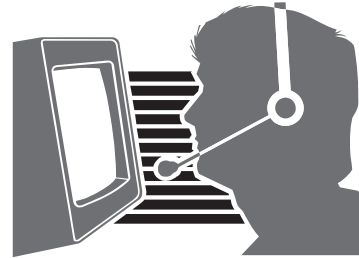

Please have your system serial numbers handy before you call. You can get these serial numbers from the control unit's Modem Status and Antenna Status menus.





# Appendix A Wiring Diagram

This appendix provides a system wiring diagram. For detailed installation instructions, refer to the Installation Guide.

## Contents

Wiring Diagram..... 75

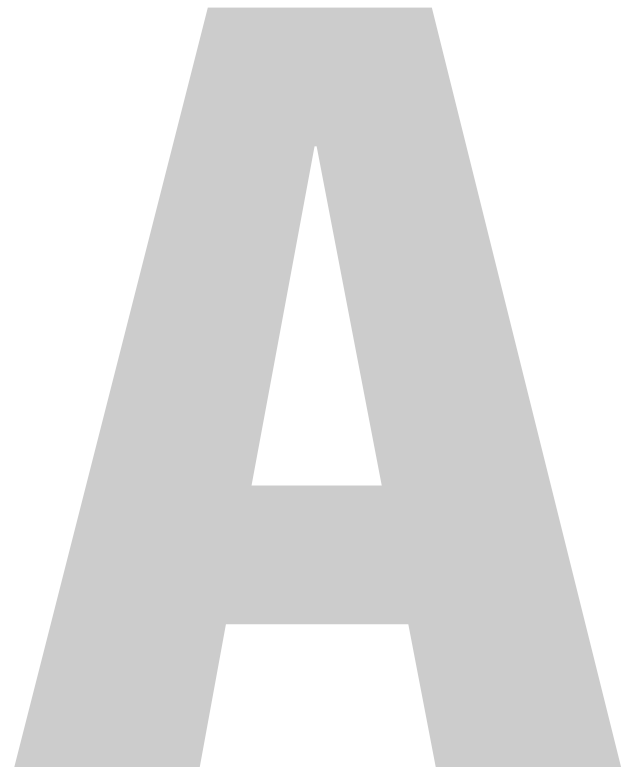

# Wiring Diagram

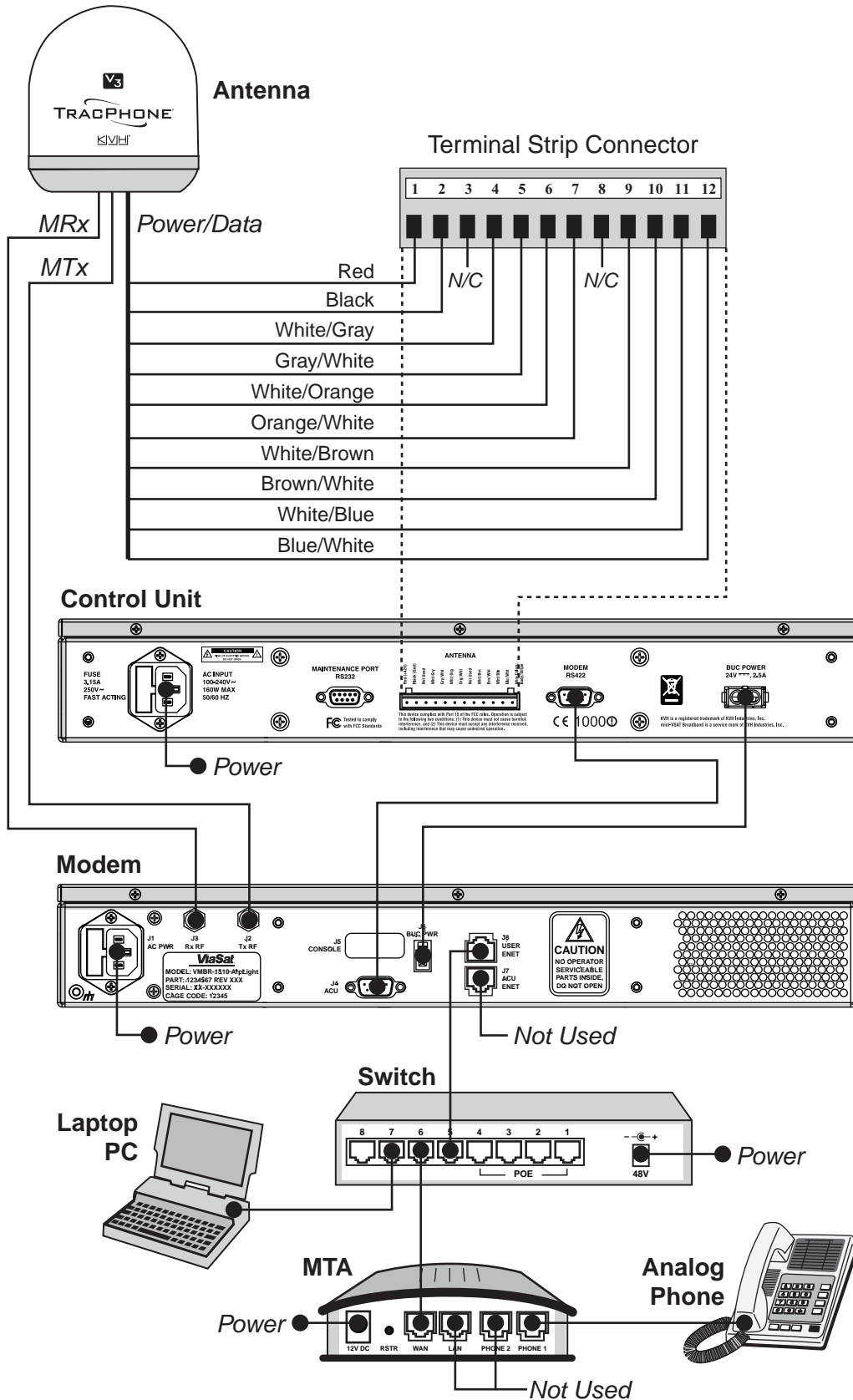



# Appendix B

# Menu Quick Reference

# Guide

This appendix provides a quick reference guide to the control unit menus.

## Contents

Menu Quick Reference Guide ..... 79



# Menu Quick Reference Guide

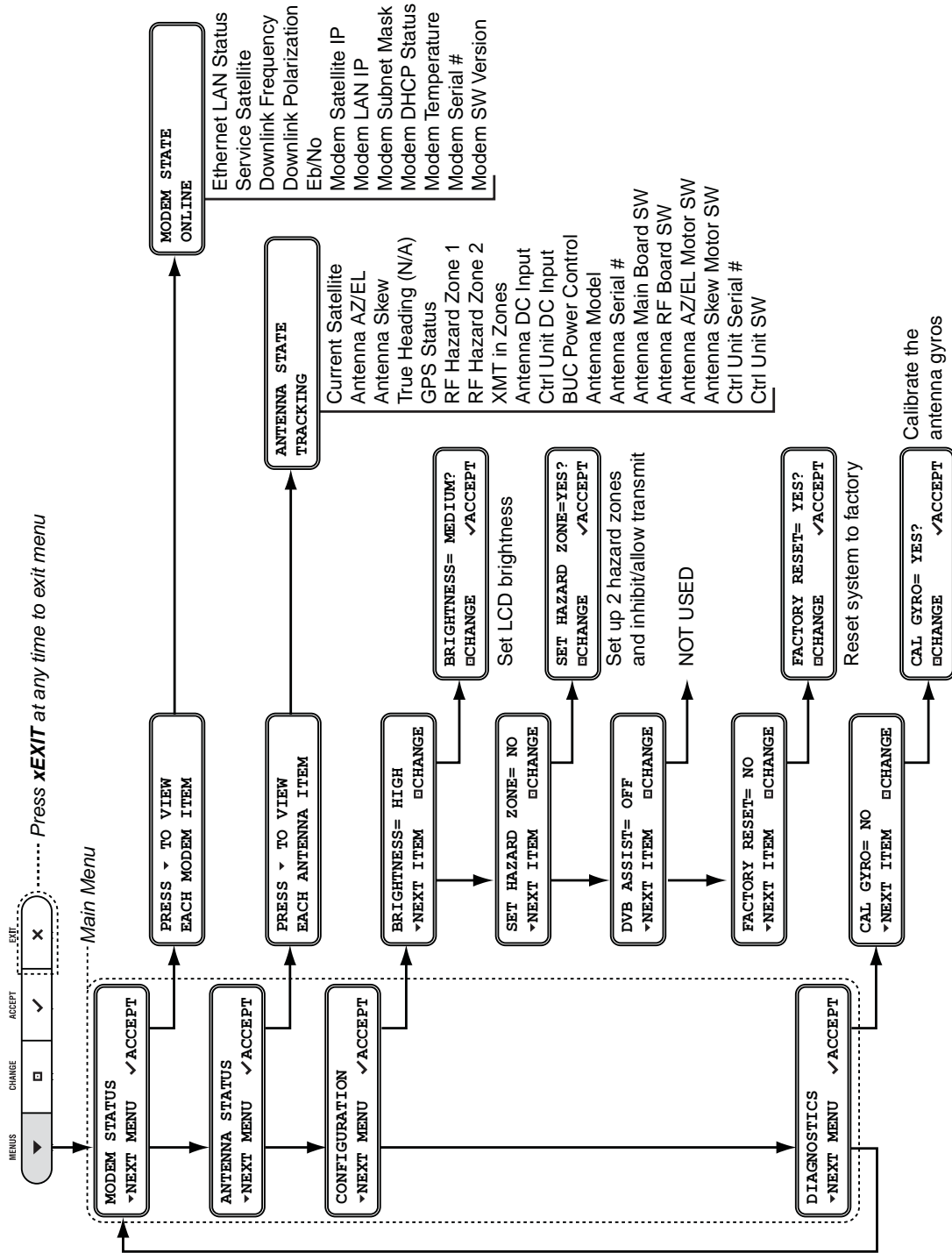



# Appendix C Glossary

This appendix provides a glossary of technical terms used throughout this manual.

## Contents

Glossary..... 83

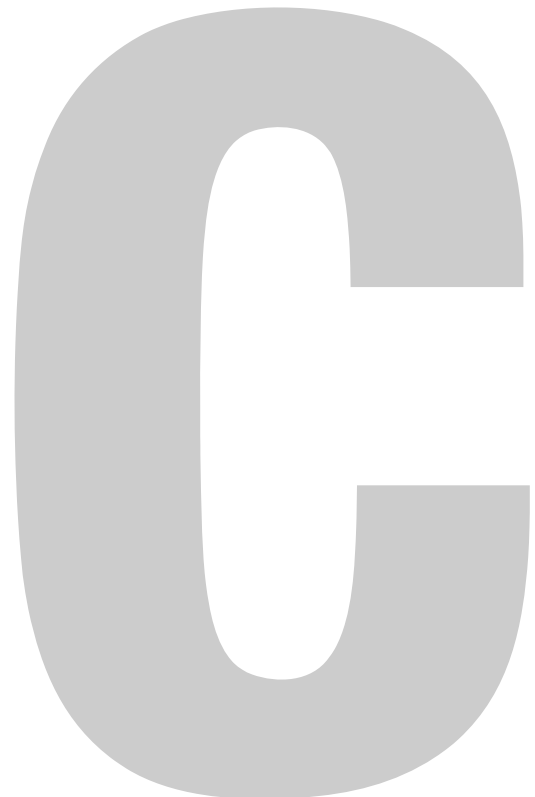



# Glossary

## 10BaseT

Ethernet standard using twisted pair cabling (such as CAT5). Supports a maximum data rate of 10 Mbps.

## 100BaseT

Fast Ethernet standard using twisted pair cabling (such as CAT5). Supports a maximum data rate of 100 Mbps.

## 802.11

Wireless network communications standard commonly used in LANs.

## AC

Alternating Current.

## AGC

Automatic Gain Control. Function that automatically boosts the gain of a received signal, as required, to maintain a constant output level. Indicates RF level.

## Analog Phone

Standard telephone, also referred to as POTS (Plain Old Telephone Service). Voice signals are converted into electrical pulses by modulating a carrier signal.

## AZ

Azimuth angle. Horizontal direction in which the antenna points.

## BUC

Block Up-Converter. Device that converts the intermediate frequency signal from the modem to a Ku-band frequency and amplifies it for transmission.

## Bulletin Board

Communications from the hub to all terminals within its network.

## CAT5

Category of twisted pair cable with a maximum data rate of 1,000 Mbps.

## **Chassis**

The outside enclosure of an electronic device.

## **Crossover Cable**

Cable in which the pins are reversed from one end to the other. Used for connecting two computers back-to-back without using an Ethernet hub.

## **Data Rate**

Speed at which a communications path can transfer information, normally measured in bits per second (bps).

## **bps**

Bits per second.

## **dB**

Decibel. Ratio of one power level to another.

## **DC**

Direct Current.

## **DHCP**

Dynamic Host Configuration Protocol. IP protocol that allows a server to automatically assign IP addressing information to a networked computer or device.

## **DNS**

Domain Name Service. IP service that translates domain names (such as "www.kvh.com") into IP addresses (such as "63.105.58.10").

## **Downlink**

Communication path from the satellite to the antenna.

## **DVB**

Digital Video Broadcasting project. Global standard of digital broadcasts.

## **Eb/No**

Ratio of Energy-per-bit to Noise power spectral density, indicating the general quality of a received signal.



## **EIRP**

Effective Isotropic Radiated Power, measured in dBW.

## **EL**

Elevation angle. Vertical direction in which the antenna points.

## **Encryption**

As it applies to WiFi, encoding of a wireless signal to protect it from unauthorized reception.

## **Ethernet**

Network communications standard adopted by most LANs. Communicates via twisted pair cable at one of three maximum data rates: (1) Standard - 10 Mbps, (2) Fast - 100 Mbps, and (3) Gigabit - 1 Gbps (1,000 Mbps).

## **Firewall**

Security mechanism that protects a network from unauthorized access.

## **Footprint**

Coverage area of a satellite.

## **Forward Link**

Communication path from the satellite hub to the user terminal. Another term for "Downlink."

## **Frequency**

Number of cycles per second of a radio wave, measured in Hertz (Hz).

## **GPRS**

General Packet Radio Service. High-speed wireless data communications standard.

## **GPS**

Global Positioning System. Network of satellites that allow anyone with a GPS device to accurately fix their position on Earth.

## **Gyro**

A device that precisely senses and measures motion in a single axis, such as elevation or azimuth.



## **Host**

Any computer connected to a network.

## **HTTP**

HyperText Transfer Protocol. The primary protocol for the World Wide Web.

## **Hub**

Earth station that links the satellite network to the terrestrial network.

## **IF**

Intermediate Frequency. As it applies to TracPhone V3, L-band output of an LNB, or input to a BUC.

## **Internet**

Global network connecting a vast number of networks and computers.

## **IP Address**

Unique network identifier assigned to a single computer or device on a network. Consists of four eight-bit numbers, each between 0 and 255 (for example, "195.172.7.2").

## **Kbps**

Kilobits (1,000 bits) per second.

## **Ku-band**

Range of frequencies from 10.7 GHz to 18 GHz.

## **LAN**

Local Area Network. A relatively small group of computers and devices linked together within close proximity to each other and usually on the same IP network.

## **L-band**

Range of frequencies from 950 MHz to 2150 MHz.

## **LNB**

Low Noise Block down-converter. Device that converts and amplifies a Ku-band satellite signal into an intermediate frequency (IF) L-band signal.

## MTA

Multimedia Terminal Adapter. Device that converts analog telephone signals into voice over IP (VoIP) signals.

## MAC Address

Media Access Control Address. Unique six-byte hardware identifier assigned to every network interface card (NIC). Used in most LAN configurations to ensure the correct addressing of data to specific hosts.

## Mbps

Megabits (1,000,000 bits) per second.

## Modem

Modulator-demodulator. Translates digital signals into analog signals and vice-versa.

## Network

A group of computers and devices (such as printers) linked together.

## Network Operations Center (NOC)

Station that maintains and manages a telecommunications network.

## NIC

Network Interface Card. Expansion or built-in circuit card that provides a computer with network communication capabilities.

## Packet

Part of a data message transmitted over a network. Also contains the address of the destination for routing purposes. *(Data messages are divided into packets, sent over a network, then reassembled in the correct order at the destination.)*

## PCI

Peripheral Component Interconnect. Bus standard that supports high-speed connections between computers and peripheral devices.

## PCMCIA

Personal Computer Memory Card International Association. Organization that establishes standards for PC cards, credit card-sized memory or input/output devices, primarily used in laptops.

**Ping**

Software utility used to check a network connection. Sends a test packet to the designated address and reports how long it takes to receive a response.

**Polarization**

Orientation of a satellite signal. Circular polarization, which has a “corkscrew” propagation path, consists of left-hand (LHCP) and right-hand (RHCP) signals. Linear polarization consists of vertical and horizontal signals offset by 90 degrees.

**Protocol**

Standard that establishes strict rules for how data is communicated over a network.

**Return Link**

Communication path from the antenna to the satellite. Another term for “Uplink.”

**RF**

Radio Frequency.

**RJ45**

Registered Jack 45. Eight-wire network cable connector for LANs. Similar to a telephone jack.

**Router**

Device that connects multiple IP networks. For each data packet it receives that is destined for another IP network, determines the best path to reach its destination.

**RSSI**

Receive Signal Strength Indicator. Indicates the strength of the received satellite signal. The modem supplies this data to the control unit for tracking purposes.

**Rx**

Receive.



## Skew

Adjustment angle to orient an LNB with a linearly polarized satellite signal.

## Spread Spectrum

A type of communication method by which the information signal energy is spread over a frequency band much wider than the minimum bandwidth required for transmitting the information.

## SSID

Service Set Identifier. Unique identifier shared by all computers and devices on a single wireless network.

## Straight-through Cable

Cable in which the pins at one end match the pins at the other end.

## Subnet

Subdivision of a network based on IP address. For example, with a subnet mask of "255.255.255.0," all computers and devices assigned an IP address starting with "195.172.8" belong to one subnet (there are 255 possible). An IP address starting with "195.172.9" designates a different subnet.

## Subnet Mask

Divides the latter portion of an IP address into subnet and host designations. For example, in a regular class B network, the first two numbers in an IP address define the network ID while the last two numbers define the host ID (the individual computer or device on that network). A subnet mask changes the format of these last two numbers by designating the third number as the subnet ID and designating the last number as the host ID (the computer or device *within that subnet*).

## SW

Software.

## Switch

Device that connects two segments of a LAN. Routes data from one segment to another based on the MAC address of the destination.

## TCP/IP

Transmission Control Protocol/Internet Protocol. Two communications protocols for the Internet. IP handles the delivery of data packets over the Internet; TCP ensures that all data packets are successfully delivered and assembled in the proper order.

## Twisted Pair

Cable type consisting of multiple pairs of cable in which two wires are spiraled together to reduce electromagnetic noise. Can be either shielded (STP) or unshielded (UTP). Used extensively in LANs and telephone networks.

## Tx

Transmit.

## URL

Uniform Resource Locator. Address of a web page or file on the World Wide Web. Consists of three parts: (1) protocol (such as "http"), (2) IP address or domain name (such as "www.kvh.com"), and (3) name of the web page or file to be retrieved from that address (such as "index.html").

## USB

Universal Serial Bus. Bus standard for connecting peripheral devices to a computer. Supports a data rate of 12 Mbps.

## UTP

Unshielded Twisted Pair. Cable consisting of four twisted pairs (8 wires), usually terminated by RJ45 connectors. Commonly used in LANs.

## VoIP

Voice over Internet Protocol. Allows telephone conversations to be routed via the Internet.

## VSAT

Very Small Aperture (< 3m) Terminal. Communications system in which multiple users connect via satellite to a single land-based hub, which handles the routing of all network traffic.

## **WAN**

Wide Area Network. A group of computers, devices, and possibly LANs, linked together over a large geographic area.

## **WAP**

Wireless Network Access Point. Device that links computers wirelessly to a LAN. To communicate with the WAP, each computer needs a properly configured wireless network card.

## **WEP**

Wired Equivalent Privacy. Security mechanism for wireless networks. Encrypts data to protect it from unauthorized interception.

## **WiFi**

Wireless Fidelity. Refers to an 802.11 wireless network.

## **WINS Resolution**

Windows Internet Naming Service Resolution. Organizes the names of all Windows computers in a network with their respective IP addresses. Similar function to DNS.

## **Wireless Network Card**

PCI or PCMCIA card that provides a computer with wireless access to a LAN via a WAP.

## **Xponder**

Transponder. Component of a satellite that receives radio transmissions from Earth, amplifies them, and retransmits them back to Earth on a different frequency.



[www.kvh.com](http://www.kvh.com)

**KVH Industries, Inc.**  
Middletown, RI U.S.A.  
Tel: +1 401 847 3327  
Fax: +1 401 849 0045  
E-mail: [info@kvh.com](mailto:info@kvh.com)

**KVH Europe A/S**  
Kokkedal, Denmark  
Tel: +45 45 160 180  
Fax: +45 45 160 181  
E-mail: [info@kvh.dk](mailto:info@kvh.dk)

**KVH Norway AS**  
Horten, Norway  
Tel: +47 33 03 05 30  
Fax: +47 33 03 05 31  
E-mail: [commboxsales@kvh.com](mailto:commboxsales@kvh.com)

**KVH Singapore**  
Singapore  
Tel: +65 6829 2343  
Fax: +65 6829 2121  
E-mail: [infokvhsingapore@kvh.com](mailto:infokvhsingapore@kvh.com)