

Beam User Manual

Iridium Extreme PTT

Grab 'N' Go Kits

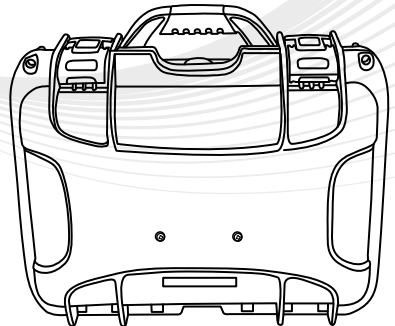

Iridium Extreme PTT Grab 'N' Go Grab 'n' Go Kits Installation and User Manual

Product names:

Iridium Extreme PTT Grab 'N' Go Corded Large Kit
Iridium Extreme PTT Grab 'N' Go Corded + UPS Large Kit

Iridium Extreme PTT Grab 'N' Go Wireless Large Kit
Iridium Extreme PTT Grab 'N' Go Wireless + UPS Large Kit

Iridium Extreme PTT Grab 'N' Go Privacy Handset Kit
Iridium Extreme PTT Grab 'N' Go Privacy Handset + UPS Kit

Iridium Extreme PTT Grab 'N' Go Corded Small Kit
Iridium Extreme PTT Grab 'N' Go Wireless Small Kit

Manual Part #: USRMAN008401

Manual revision: 1

Release date: December 2016

Beam Communications Pty Ltd
5/8 Anzed Court, Mulgrave,
Victoria, 3170, AUSTRALIA

Information furnished by Beam Communications Pty Ltd is believed to be accurate and reliable. However, no responsibility is assumed by Beam for its use, or for any infringement of patents or other rights of third parties, which may result from its use. No license is granted by implication or otherwise under any patent or patent rights of Beam. Beam reserves the right to change specifications at any time without notice.

Beam Communications



Beam Communications, a wholly owned subsidiary of World Reach Limited (WRR), listed on the Australian Stock Exchange, is a world leader in design, manufacture and distribution of specialized communications equipment for the Iridium Satellite Network.

Beam's commitment to be at the forefront has continued to increase its share of the global satellite communications market. Its premium distribution network spans the world. Recognized as a leading provider of satellite communication solutions, Beam specializes in Voice, Data, Tracking and customized solutions. Beam develops innovative products and services to meet market demands and niche applications.

Beam's leading edge products are deployed in a wide range of markets including Maritime, Transport, Government, Defence, Mining, Construction, Forestry, Emergency Services, Relief Aid, Telemetry and Rural Telephony.

Supported by a dedicated team of professionals, Beam has developed solid relationships with its peers and network of distributors worldwide.

Beam Communications Pty Ltd
5/8 Anzed Court, Mulgrave,
Victoria, 3170, AUSTRALIA

Web: www.beamcommunications.com
Info: info@beamcommunications.com
Support: support@beamcommunications.com

Tel: +61 3 8588 4500
Fax: +61 3 9560 9055

Contents

Beam Communications	3	General Operation (Wireless Handset only)	17
Contents	4	Dock Loudspeaker Operation (Corded and Wireless Handset)	18
Conventions in this Manual	5	DriveDOCK Extreme Button LED Status (PTT Mode)	19
Terminology	5	DriveDOCK Extreme Button LED Status (Phone Mode)	19
Kit Contents	6	DriveDOCK Extreme Button Action & Response (Phone Mode)	20
Safety Warnings	6	DriveDOCK Extreme Button Action & Response (PTT Mode)	21
Product Overview	8	Technical Notes	22
Dock PTT Mode versus Phone mode	9	Accessories	24
Beam WIRELESS PTT HANDSET	10	Type Acceptance	25
Wireless PTT Parts & functions	10	Radio and Television Interference	25
Wireless Charging Cradle Parts & Functions	10	Important Safety and Handling Information	26
Beam CORDED PTT HANDSET	11	Informations importantes de sécurité et de manutention	28
Installation	12	Specifications	31
Firmware for DriveDOCK Extreme	12	Beam Warranty Conditions	32
Extended Iridium Extreme® Battery (Optional)	12		
Mounting Bracket (wireless & corded)	12		
Iridium Extreme® PTT Operation	14		
Registering	14		
PTT Mode	14		
Phone Mode	15		
PTT Operation	15		
PTT Session Status	15		
Using SOS	16		

Conventions in this Manual

Warnings, cautions and notes appear throughout this manual are represented by following conventions.

WARNING / CAUTION:



This symbol and associated text indicate a warning note providing information to prevent damage to equipment or personal injury.

IMPORTANT / TIP:



This symbol and associated text indicate a note providing general operating information.

INTERFERENCE:



All wireless phones may get interference, which could affect performance.

Terminology

TERM	DESCRIPTION
PTT	Push-To-Talk
Eagle	Extreme Docks Configuration Tool - MS Windows Install
GPS	Global Positioning System
HF	Hands-free
Mobile Originating	Describes a call initiated by the DriveDOCK Extreme
Mobile Terminating	Describes an incoming call being answered by the DriveDOCK Extreme
Iridium Extreme® PTT device	The Iridium Extreme® Satellite Telephone
Dock	Beam DriveDOCK Extreme
Corded Handset	Beam Corded Push-To-Talk Handset
Wireless Handset	Beam Wireless Push-To-Talk Handset
®	The ® symbol, mark and logos are owned by the respective companies of which the symbol follows. Any use of such marks by Beam Communications is under license. Other trademarks and trade names are those of their respective owners.
RF	Radio Frequencies
AT	Attention command
SMA	Sub Miniature version A co-axial RF connection
RP-SMA	Reverse Polarity – Sub Miniature connectors.
FCC	Federal Communications Commission. Independent agency of the US government that regulates communications.
RSS	Radio Standards Specifications. Industry Canada's documents that describe the processes and requirements for compliance of radio apparatus.

Grab 'n' Go Kit Variants

Your chosen Extreme PTT Grab 'n' Go Case contains the following:

- PTTGNG-C1 - Iridium Extreme PTT Grab 'N'Go Corded Large Kit
- PTTGNG-W1 - Iridium Extreme PTT Grab 'N'Go Wireless Large
- PTTGNG-P - Iridium Extreme PTT Grab 'N'Go Privacy Handset Kit
- PTTGNG-C1B - Iridium Extreme PTT Grab 'N'Go Corded + UPS Large Kit
- PTTGNG-W1B - Iridium Extreme PTT Grab 'N'Go Wireless + UPS Large
- PTTGNG-PB - Iridium Extreme PTT Grab 'N'Go Privacy Handset + UPS Kit
- PTTGNGS-C1 - Iridium Extreme PTT Grab 'N'Go Corded Small Kit
- PTTGNGS-W1 - Iridium Extreme PTT Grab 'N'Go Wireless Small Kit

Optional Extreme Dock Accessories

The following optional accessories are available for your Iridium Extreme PTT Grab 'N' Go Large Kits:

- RST060 - Battery (Bracket required)

See your service provider for pricing and availability of the above quality BEAM accessories.

Additional Information

For the latest in supporting software and documentation for Extreme PTT DriveDOCK please visit www.beamcommunications.com/support/drivedockextreme

Other Resources Available Online

- Iridium Antenna Installation Guide and User Manual
- DriveDOCK Extreme User Manual and Quick Start Guide
- Iridium PTT Extreme User Guide

Safety Warnings



IMPORTANT

Please read the following information carefully before using the Iridium Extreme PTT Grab 'N' Go Kits. Failing to follow instructions may compromise the safety of the product and may result in personal injury and/or equipment damage. Please consult your supplier if you have any further questions.

The DriveDOCK Extreme is a low power docking station for the Iridium Extreme® or Iridium Extreme® PTT device. When ON, it will charge the Extreme handset whilst docked in the DriveDOCK.

- *Store the system in a cool and dry area.*
- *Do not submerge the system in water.*
- *Do not place foreign metal objects or debris in the system. If debris enters into the system, please return to factory for service.*



WARNING

DO NOT open the equipment. There are no user serviceable parts inside. If a DC power supply is to be used, the output must comply with the Safety Extra Low Voltage (SELV) requirements of IEC60950. All connectors must only be connected to equipment ports which comply with the Safety Extra Low Voltage (SELV) requirements of IEC60950.

WARNING: POTENTIALLY EXPLOSIVE ATMOSPHERES

- *Turn your 9575 Extreme device and Wireless PTT Handset OFF and DO NOT remove the battery or remove the 9575 Extreme device / Wireless PTT Handset from the cradle when you are in any area with a potentially explosive atmosphere.*
- *Obey all signs and instructions.*
- *Sparks from your battery in such areas could cause an explosion or fire resulting in bodily injury or even death.*
- *Areas with a potentially explosive atmosphere are often but not always clearly marked. They include, but are not*

limited to:

- » fuelling areas such as gasoline stations
- » below deck on boats;
- » fuel or chemical transfer or storage facilities;
- » areas where fuel odours are present (for example, if a gas/propane leak occurs in a car or home);
- » areas where the air contains chemicals or particles, such as grain, dust, or metal powders;
- » any other area where you normally would be advised to turn off your vehicle's engine.

WARNING: ROAD SAFETY COMES FIRST!

Do not use a hand-held cellular terminal, satellite phone or mobile when driving a vehicle, unless it is securely mounted in a holder for speaker phone operation. Before making a call with a handheld terminal, satellite phone or mobile, park the vehicle stationary. Please obey local road laws for hands-free speakerphone operation. Speakerphones (hands-free) must be installed by qualified personnel. Faulty installation or operation can constitute a safety hazard.



WARNING

Changes or modifications not expressly approved by Beam Communications could void the product warranty.

WARNING: AIR BAG EQUIPPED VEHICLES

An air bag inflates with great force. Do not store or mount the Cradle / PTT system or any of the accessories in the area over the air bag or in the air bag deployment area.

WARNING: HEADSET USE

Headsets and earpieces used with this product are capable of delivering sounds at loud volumes. Exposure to such sounds can result in permanent hearing loss damage. The volume level may vary based on conditions such as the docks volume settings and the environment.

Please read the following safety guidelines below prior to using a headset or earpiece:

1. Prior to using this product follow these steps:
 - Before putting on the headset, turn the volume

control to its lowest level,

- Put the headset on, and then slowly adjust the volume control to a comfortable level.
2. During the use of this product:
 - Keep the volume at the lowest level possible and avoid using the headset in noisy environments where you may be inclined to turn up the volume;
 - If increased volume is necessary, adjust the volume control slowly.
 - If you experience discomfort or ringing in your ears, immediately discontinue using the headset and consult a physician.

With continued use at high volume, your ears may become accustomed to the sound level, which may result in permanent damage to your hearing without any noticeable discomfort. Using a headset while operating a motor vehicle, motorcycle, watercraft may be dangerous, and is illegal in some jurisdictions. Check your local regulations and laws.

Product Overview

The Iridium Extreme PTT Grab 'N' Go Kits provide a high quality portable transport solution using the Iridium Extreme PTT Service. Combined with Beam's Wireless or Corded Push-To-Talk (PTT) Handset Accessory Kit, in conjunction with the Beam Extreme DriveDOCK, the easy to carry cases extend the power of the Iridium Extreme® PTT Device to the palm of your hand, whether in or out of a vehicle, anywhere you need to go!

The inbuilt Beam PTT handset kit (wireless or corded) is ideal for various applications such as Emergency Services, Commercial Transportation, Mining Industry, Defence, Government, no matter the type or size of operation, you can depend on the Beam PTT to perform.

The Beam PTT handset key features:

- Durable and reliable mic/speaker handset
- Enhanced clean audio quality
- Compatible with existing Beam DriveDOCK Extreme
- Supports both Phone and PTT modes of the Iridium Network
- Ability to amplify PTT audio to external cabin loudspeaker
- Left or Right side bracket mounting to the Dock

Beam DriveDOCK Extreme requires firmware version 1.5 or higher to be compatible with the Iridium Extreme® PTT device.

PTT Case Types:

Corded Push-To-Talk Handset

Available in the large and small case.



Wireless Push-To-Talk Handset

Available in the large and small case.



Privacy Handset Push-To-Talk

Available in the large case only.

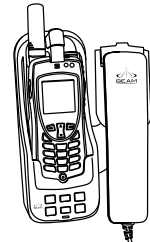
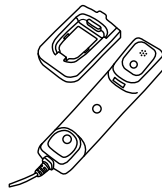

NOTE: Privacy Handset has the ability to receive audio via push of a button to the Iridium PTT Extreme device.

Dock PTT Mode versus Phone mode

When the 9575 Extreme device is in PPT mode, some of the Extreme Dock functions are altered (please refer to pg. 18-19 for more details):

FUNCTION	EXTREME DOCK in PTT MODE
Wired Alert Loop	Disabled (No alert/SOS functionality exists in the 9575 Extreme device when in PTT mode.)
Mute Function	Disabled. If the button is pressed during PTT mode, the mute button will flash 3 times in ORANGE and sound the “Triple beep rising tones” to the Dock buzzer & the current loudspeaker to indicate the 9575 Extreme device is in PTT mode.
Bluetooth®Audio	Disabled
Privacy Handset	Please refer to page 18 and 19 for a detailed description.
Volume Buttons	During PTT mode, the volume changes affect BOTH the dock’s external speaker AND the PTT handset’s speaker.
Tracking	Tracking is not supported during PTT mode (both instant tracking and interval tracking messages are suspended).
Track Button	Disabled. If the Track button is pressed during PTT mode, the mute button will flash 3 times in ORANGE and sound the “Triple beep rising tones” to the Dock buzzer & the current loudspeaker to indicate the 9575 Extreme device is in PTT mode.
Horn Alert	Disabled
Entertainment Mode	Disabled
Cabin Handsfree audio	Disabled



IMPORTANT

During PTT mode, all Alert Loop functionality is DISABLED. If the alert loop is triggered in PTT mode there are no messages sent, no beeping tones, no flashing LED.

Iridium Extreme PTT Grab 'N' Go Kits - Large case Handset Parts & Functions

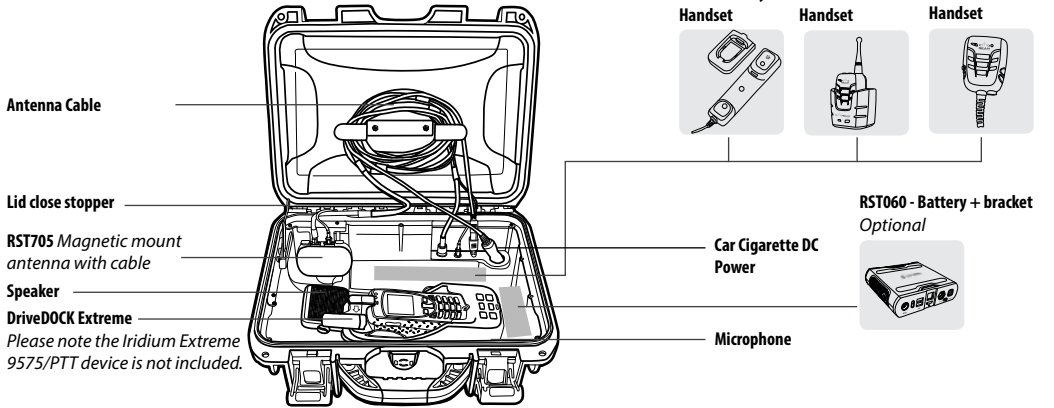

Iridium Extreme PTT Grab 'N' Go Kits - Small case Handset Parts & Functions

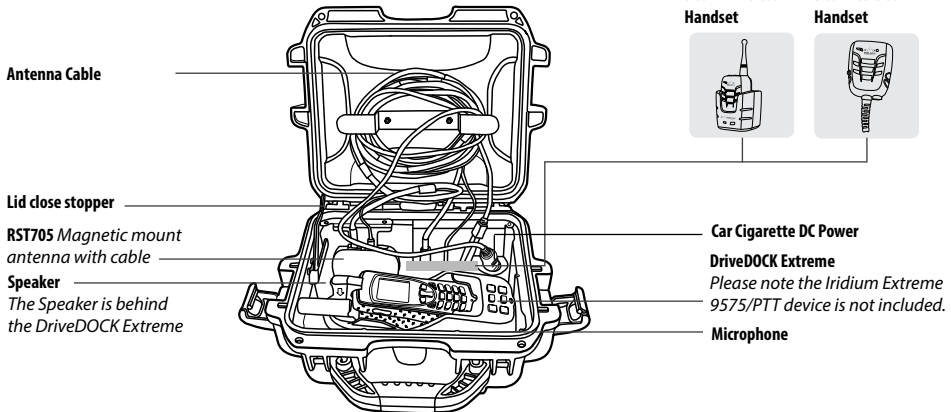

Beam Wireless PTT Handset

Wireless PTT Handset Parts & Functions

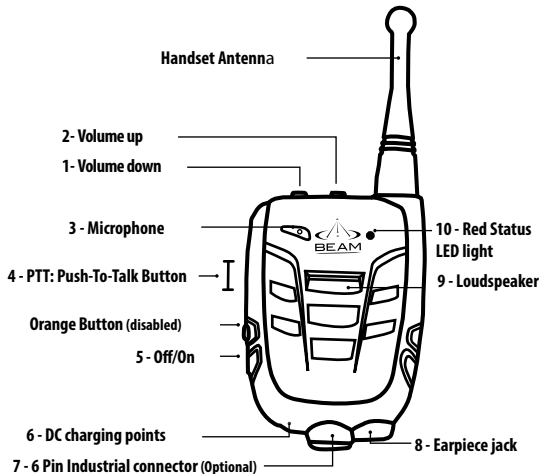

1 - Volume down (Blue button): adjusts speaker audio to a softer minimum setting.

2 - Volume up (Blue button): adjusts speaker audio louder.

3 - Microphone: Speak in normal volume as you would on a phone.

4 - PTT Button (Black button): 3 quick beeps when pressed. When out of range the Wireless PTT Handset will sound a slow beeping tone alert.

5 - Off/On (Grey button): hold for about 5 seconds to turn on or off. The Wireless PTT Handset will sound escalating or de-escalating tones

6 - DC charging points: place handset into charging cradle to automatically re-charge.

7 - 6 Pin Industrial connector: use with optional headsets/accessories.

8 - Earpiece jack: allows private listening via 3.5mm earpieces. Inserting the 3.5mm jack mutes the loudspeaker.

9 - Loudspeaker: Delivers loudspeaker audio. Automatically mutes when inserted into charging cradle.

10 - Red Status LED light: The handset and the cradle LED show the same notification. Glows red when connected and operational. Flashes when "out of range" or when one unit is off.

11 - Antenna Connector: Allows connection of long range external antenna in replacement of the short range stick antenna.

Note:

1. When wearing your Wireless PTT handset, it will perform best when worn with the handset antenna extending above your shoulder.
2. The Orange Button is disabled. It is reserved for future use.

Wireless Charging Cradle Parts & Functions

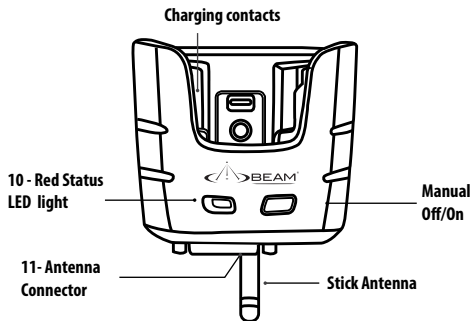

PTT Handset retaining Clip

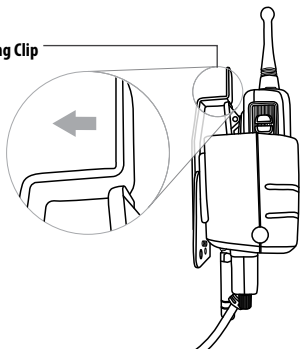

WARNING

The Beam Wireless PTT Handset and charging cradle are designed to radiate low levels of radio energy in accordance with global government approved regulatory standards. It features Adaptive Power Output. APO automatically adjusts the RF power output in accordance with signal required. This features limits and reduces extraneous radiated radio energy. This also helps minimize battery consumption and extends battery shelf life.

Do not touch the antenna when operational. Keep Secure Microphone antenna 25mm (1") or more away from your face and body to ensure exposure levels remain at or below the maximum levels. Keep your body at least 20cm/8" from external antennas connected to the charging cradle.

Ne touchez pas l'antenne lorsque opérationnel. Gardez sécurisé



IMPORTANT

Always attach the antenna to the charging cradle before connecting the interface cable.

Beam Corded PTT Handset

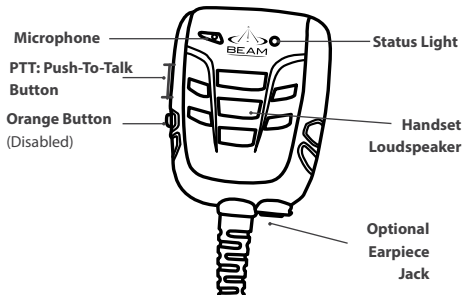

The Beam Corded Handset contains a microphone and loudspeaker for independent conversion up to a stretched distance of 1 m from the Dock.

The status light will be ON whenever the PTT button has been pressed.

Beam Privacy Handset

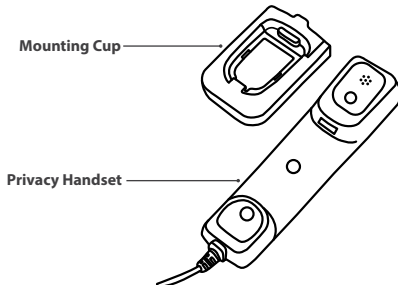

Iridium Extreme® PTT Operation

Registering

Insert the Iridium Extreme® PTT device into the Dock, and ensure the Dock is powered on (via vehicle key or alternative power source). The dock will detect and boot the Extreme PTT device to its last known mode.

PTT Mode

To change from Phone Mode to PTT Mode:

1. Press the **left soft key**, labelled **Menu**.
2. Press the **left soft key**, labelled **Select**.
3. Wait for the device to switch to PTT Mode.

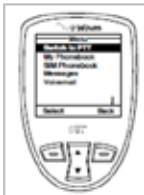

4. The transition to PTT mode takes approximately 10 seconds. A "PTT" designation will appear at the top center of the screen when the transition is complete and the device will identify your Home Talkgroup at the bottom of your screen (e.g., Talkgroup 1).

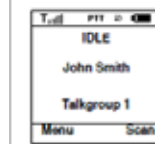

Phone Mode

To change from PTT Mode back to Phone Mode:

1. Press the **left soft key** (on the Iridium Extreme® PTT device)
2. Select the **Switch to Phone** option at the top of the menu list.

PTT Operation

To start a Push-to-Talk call, push and hold the Push-to-Talk (**PTT**) **Button** on the Beam handset, and continue to hold the button until you are granted the floor to talk. Initially, you will hear a series of connecting tones that will beep on one second intervals, followed by either a Talk Tone (three notes in ascending tone in rapid succession) or a Reject Tone (two notes in descending tone in rapid succession) that will occur if the service is busy or unavailable (a corresponding message will be displayed on the screen when this occurs).

After receiving the Talk Tone, continue holding the **PTT Button** and be sure to keep the button pressed while you

are speaking and to release it when you are finished. You will have up to 20 seconds to speak during each transmission before the floor becomes open for others to speak.

If you have configured your device with Talk Timer **Enabled**, the time remaining to speak in the current talk period is displayed on the screen below the Device Name.

When 20 seconds has elapsed, **Time Expired** is displayed on the screen and the device moves to the OPEN status, giving others in the talkgroup session a chance to speak.

PTT Session Status

A talkgroup is a collection of Iridium Extreme® PTT devices that have been provisioned to transmit content to each other within a specified geographic area(s). Refer to the Iridium Extreme® PTT User Guide for more information.

When your Iridium Extreme® PTT device is monitoring a talkgroup (not in Scan State), the screen displays one of four states: IDLE, LISTENING, TALKING and OPEN.

IDLE: When a talkgroup is not active in the network, the devices that have the talkgroup as their Home Talkgroup will display IDLE.

LISTENING: When a talkgroup is active and a participant has the floor, the devices that are participating in the talkgroup will display LISTENING.

TALKING: When a talkgroup is active and a participant has the floor, the device that has the floor will display TALKING.

OPEN: When a talkgroup is active but no one has the floor,

the devices that have the talkgroup as their Home Talkgroup will display OPEN.

Using SOS

If you attempt to press the SOS button while in PTT Mode, you will receive the following notification: "WARNING! Must go to Phone Mode for SOS."



To change the Iridium service to Phone mode, Press the left soft key (on the Iridium Extreme® PTT device), labelled **Phone**, to switch to Phone Mode. While transitioning, you will be prompted to "Press SOS again when in Phone Mode". You must press the SOS button again in Phone Mode to successfully initiate an SOS call.



IMPORTANT

The Dock Alert loop will not trigger an alarm while the phone is in PTT mode

Tracking Functionality

When in PTT mode, the tracking functionality (interval and instant tracking messages) is DISABLED.

Navigating to Phone Mode to Dial

If you attempt to dial a phone number while in Push-To-Talk mode, you will receive the following notification: "Dialing not supported. Must go to Phone mode to dial".



Press the **left soft key**, labelled **Phone** to switch to Phone Mode. As you are transitioning, you will be prompted to "Dial number again when in Phone Mode". Numbers dialed in PTT Mode must be re-entered once you switch to Phone Mode, and the call must be initiated in Phone Mode to connect successfully.



IMPORTANT

For a comprehensive description of all the features of the Push-To-Talk functionality in the 9575 Extreme device, see the Iridium Extreme® PTT User manual.

General Operation (Wireless Handset only)

Power On & Off

The Wireless PTT Handset and charging cradle powers on with the Beam Extreme Dock. Note that the Wireless PTT Handset **does not** power off when the Extreme Dock is turned off. You can manually turn off the charging cradle by pressing the front grey button for 3 seconds and the red status LED will switch off. You can do the same on the Wireless PTT Handset by pressing the grey button. The handset will sound a de-escalating tone. To power On, press the grey button and releasing the button once the LED status lights turn on and the handset will sound an escalating tone. The red status LED on both units will flash momentarily and then go solid once they're connected.

Volume Control

When you first activate the unit you should first ensure your handset volume is set to a comfortable listening level. You may then adjust the Wireless PTT Handset volume by pressing the top right button to increase or the left to decrease. There are 5 listening levels. The minimum level is not zero but is designed so you can still quietly hear radio traffic and not inadvertently turn off the audio.

Transmitting/Receiving

Use the handset like any two-way radio speaker microphone. i.e. press the PTT button to talk and release to listen. A short talk permit tone sequence will sound when activated. Speak with a normal strong clear voice about 3-5cm (2") from the microphone port. Too hard or too soft will degrade the clarity of transmission.

Out of Range Indication

The Wireless PTT Handset provides the user with audible feedback should the user move out of range from their vehicle. If you walk out of range the red status LED will flash. If you then push the PTT an alert tone will sound to let you know your call is not getting through. Depending on your location, you may find you need to walk back about 10 meters closer to your vehicle to re-connect. The two red status LED light will then glow solid.

Talk Permit Tone

The Wireless PTT Handset provides talk permit tones so users know when to start speaking so that words are not lost at the start of a transmission. If, the channel is busy, no channel grant or you are out of range, the user will hear the Wireless Handset talk permit tones followed by the radio BUSY or Out of Range tone.

Charging Confirmation Tone

The Wireless PTT Handset provides the user with a discrete tone whenever the handset is returned to the charging cradle. This discrete tone ensures the user has a positive indication that the handset is charging and seated correctly in the cradle.

Earpiece Operation

The Wireless PTT Handset provides the user with a weather protected 3.5mm earpiece jack to allow use of industry standard earpieces thereby providing additional privacy of communications. A range of earpiece styles are available to suit individual user preferences. Plugging in an earpiece disables the internal loudspeaker.

Stealth Mode

For special applications the handset LED can be temporarily disabled. This is achieved by holding down the VOLUME UP/DOWN (both) while powering up the unit. To turn the LED back on, simply power down and power back up.

Additional Headsets

The 6 pin industrial connector at the bottom of the wireless handset also allows the use of a variety of heavy duty and lightweight headsets and application specific audio accessories to enhance your communications capability. Use either the headset/accessory's integral PTT or use the wireless handset to transmit. The internal speaker is immediately disabled when a headset is plugged in.
N.B. See page 7 for safety warning regarding use of headsets.

Accessory Mic Boost

Users can increase an audio accessory's microphone gain on the handset models fitted with the Hirose accessory port to cater for sensitivity requirements or variations in headset manufacturer's specifications. To activate the higher sensitivity, the Wireless Handset's blue VOLUME UP button should be held down while powering up. The user will thereafter hear 2 short confirmation beeps at the end of each start up tone sequence. To revert to normal sensitivity, the unit should be powered up with the VOLUME DOWN blue button held down.

NOTE: This does NOT affect the sensitivity of the handsets normal internal front cover microphone.

Dock Loudspeaker Operation (Corded, Wireless and Privacy Handset)

The Beam DriveDOCK Extreme includes the standard loudspeaker (as used in normal Phone hands-free calling). This loudspeaker can also be configured to provide audio in PTT operation. This provides an extra output in addition to the handset.

To use the DriveDOCK Extreme loudspeaker with the handset:

1. Press/hold the Dock Ringer button for 2 seconds. This will change to the DriveDOCK Extreme loudspeaker mode, and will be signified by playing the triple rising tone in the DriveDOCK Extreme speaker and PTT speaker. Also the Ringer LED will flash GREEN 3 times.
2. Audio is now set to output on both the DriveDOCK Extreme speaker and the handset.

To revert to using the handset speaker only:

1. Press/hold the Dock Ringer button for 2 seconds. This will change to the handset speaker mode, and will be signified by playing the triple rising tone in the Wireless Handset speaker (not the DriveDOCK Extreme speaker). Also the Ringer LED will flash GREEN 3 times.
2. Audio is now set to be silent to the DriveDOCK Extreme loudspeaker. The audio output setting is saved even when the dock is switched off.

PTT Grab 'n' Go Case - Phone Mode

MODE	Default Mode Mode 1. HFI (Hands Free - External Speaker and Mic Only)	Mode 2. Corded/ Wireless PTT Handset Only (HFI Disabled)	Mode 3. Corded/Wire- less PTT Handset and External Speaker Only	Use Mode 1 or Mode 3. with Privacy Handset and HFI
Switch Modes	While in a call press the Ringer button for 2-3 seconds to move to mode 2.	While in a call press the Ringer button for 2-3 seconds to move to mode 3.	While in a call press the Ringer button for 2-3 seconds to move to mode 1.	
Visual Indicator	Phone Mode: Mute button not lit	Phone Mode: Mute button Red	Phone Mode: Mute button Red	Per Mode 1 or 3
External Speaker	Yes	No	Yes	Yes (Privacy Handset in cup)
External Microphone	Yes	No	No	Yes (Privacy Handset in cup)
PTT Handset (Speaker/ Mic)	Speaker Only	Yes	Yes	No
Privacy Handset	No	No	No	Yes
Incoming Ring Alert	External Speaker and PTT handset	External Speaker and PTT handset	External Speaker and PTT handset	External Speaker Only
Answer a Call	9575 Green Send key OR Single Press on PTT button	9575 Green Send key OR Single Press on PTT button	9575 Green Send key OR Single Press on PTT button	9575 Green Send key (HFI) OR 9575 Green Send key and Uncup Privacy Handset OR Uncup Privacy Handset directly
Reject a Call	9575 Red End key OR Double Press on PTT button	9575 Red End key OR Double Press on PTT button	9575 Red End key OR Double Press on PTT button	9575 Red End key
End Call	9575 Red End key OR Double Press on PTT button	9575 Red End key OR Double Press on PTT button	9575 Red End key OR Double Press on PTT button	9575 Red End key





PTT Grab 'n' Go Case - PTT Mode

MODE	Mode 1: Default Mode External Speaker with Corded/ Wireless Handset	Mode 2: Corded/Wireless Hand- set Only	Mode 1: With Privacy Handset Only
Switch Modes	Press the Ringer button for 2-3 seconds, to move to mode 2	Press the Ringer button for 2-3 seconds, to move back to mode 1	
External Speaker	Yes	No	Yes (Privacy Handset in cup)
External Microphone	No	No	Yes (Privacy Handset in cup)
PTT Handset (Speaker/Mic)	Yes	Yes	No
Privacy Handset	No	No	Yes
Make a PTT Call	Press PTT button	Press PTT button	Press 9575 convenience key (Privacy Handset uncupped)





DriveDOCK Extreme Button LED Status (PTT Mode)



	GREEN	ORANGE
Flashing	Telephony mode detected from 9575	PTT mode detected from 9575

DriveDOCK Extreme Button LED Status (Phone Mode)



	GREEN	RED	BLUE	ORANGE
ILLUMINATED	N/A	Mic / Uplink audio Mute	N/A	N/A
	GREEN	RED	BLUE	ORANGE
FLASHING (slow)	Incoming call ringing	N/A	N/A	Privacy Handset or Intelligent Handset in use.
FLASHING (fast)	N/A	N/A	Ring tone playback	N/A
	BLUE			ORANGE
ILLUMINATED	Connected with a paired BT device. Ready for accepting incoming call or switch to an active call			N/A
FLASHING (fast)	Searching a paired BT device			N/A
FLASHING (slow)	BT device is being used in a call			N/A
ALTERNATING	Bluetooth* in Discovery Mode Blue ←→Orange			
 OR 	BLUE			ORANGE
FLASHING (slow)	N/A			Error Mode (Check Error log codes in Eagle)
ALL BUTTONS				
FLASHING (slow)	N/A			Charge Only Mode – all LEDs flash (2 at a time)

DriveDOCK Extreme Button Action & Response (Phone Mode)

LOCATION	BUTTON MODE	ACTION	LED/SOUND
	Mute press On/off	In a Call: Mute the microphone (uplink) on the Hands-free, optional privacy handset, or optional Intelligent Handset	LED turns RED Muted LED turns OFF Not muted
	Up/Down OR 	In a Call: Increase/decrease volume on the audio device in use Out of Call or Incoming Ring: Increase/decrease volume of incoming ring tone on the external or internal speaker. (The lowest setting will silence the Ringer) Brightness Mode: Increase/decrease the LED intensity	Audio will sound louder/softer with each press. A beep will sound indicating the increased/decreased ring tone volume of the external or internal speaker – whichever is currently set by the Ring (Bell) button. All Button LEDs brightness will be increased/decreased with each press.
	Brightness - dual button simultaneous press (2 seconds)	Out of Call: Enter LED brightness change mode. Then Press UP and/or DOWN arrows to vary intensity. Mode will automatically exit after 5 seconds after the last button press.	Status LED flashes YELLOW 3 times and all Button LED's will change WHITE. A single beep will sound when entering brightness change mode. A short double beep will sound when exiting change mode.

LOCATION	BUTTON MODE	ACTION	LED/SOUND
	Ringer Single Press	Not in Call: Cycle through the ring tones and the output device (internal buzzer and external speaker). The last Ringer type sounded is then saved.	Ring tone playback and the output device changes. LED FLASHING (fast) BLUE when ring tone is sounded.
	3 Second Press	Cycle through audio speaker and microphone options <ul style="list-style-type: none"> • PTT/Privacy Handset • PTT/Privacy Handset and handsfree speaker • Handsfree speaker and microphone 	3 rising beep sounds
	Single Press (no beep sound)	When Bluetooth® is OFF: Turns ON Bluetooth® function If Bluetooth® connected but NOT used in Call: Transfer the audio to the Bluetooth® device Bluetooth® Device being Used in Call: Transfer the audio to HF mode, or Privacy/Intelligent handset if activated	LED changes from OFF to FAST FLASHING in BLUE when searching Bluetooth® device(s). LED turns solid BLUE when connected LED changes from Solid BLUE to SLOW FLASHING in BLUE LED changes from Slow Flashing to solid BLUE



DriveDOCK Extreme Button Action & Response (Phone Mode) continued...

LOCATION	BUTTON MODE	ACTION	LED/SOUND
	Single Press 1.5 sec (until 1 beep sounds)	Bluetooth® function is ON: Turns OFF Bluetooth® function	LED turns OFF
	Single Press 5 sec (until 2 beep sounds)	Bluetooth® function is ON: Bluetooth® is set to discovery mode for pairing to Bluetooth® devices	LED is FAST FLASHING ORANGE and BLUE, and then turns solid BLUE when paired and connected.
	Single Press 10sec (until 3 beep sound)	Bluetooth® is ON or OFF: Clear all paired Bluetooth® devices and turn off Bluetooth® function	LED turns OFF
	Single Press (until 1 beep sounds)	In Tracking Mode*: Send a tracking message to the pre-configured destination in the Extreme Handset	LED flashes GREEN for 5 seconds. A beep will sound to indicate that a tracking message is to be sent#
	Single Press 5sec (until 2 beeps sound)	Enables / Disables Track button	LED Solid GREEN is enabled, LED OFF is disabled

* This action is optional, and only when tracking for your Extreme Handset is configured and activated. Using the Track button only initiates the command to send a Quick GPS message - check that the Extreme Handset is configured correctly.

A beep will only sound if audible alerts are enabled in Eagle.

DriveDOCK Extreme Button Action & Response (PTT Mode)

LOCATION	BUTTON MODE	ACTION	LED/SOUND
	3 Second Press	Cycle through audio speaker and microphone options <ul style="list-style-type: none"> • PTT/Privacy Handset • PTT/Privacy Handset and handsfree speaker • Handsfree speaker and microphone 	3 rising beep sounds
 OR 	Up/Down	Increase/decrease volume on the audio device in use	Audio will sound louder/softer with each press.

Technical Notes

Battery Charging

The Wireless PTT Handset should be charged overnight before initial use. Thereafter it may be left in the charging cradle unit between calls, or may be worn all day and placed back at the end of the work day. The unit is designed to provide about 16-24 hours operation between charges even on the busiest radio channels. On quiet channels it can last up to 4 days. When the battery does start to go flat, a short beep will sound once every 2 minutes. It will then automatically power down after 30 minutes, so you should plan to recharge the unit as soon as is practical once the chirps are heard.

A fully discharged battery will typically recharge in less than 3-4 hours or less if only partially discharged. The Wireless Handset does not automatically power down when the Dock and cradle turns off (see ExtremeDock manual for auto powerdown feature).



IMPORTANT

To ensure the Wireless Handset is kept in a charged state, the 'PTT Continuous Charging' option must be set in the Eagle tool. Once set, this option will ensure that when the Dock goes into Sleep Mode the handset will still receive power.



IMPORTANT

Do not allow debris to fill the cradle as it may prevent the microphone from making contact with the charging pins. Keep all liquids well away from the charging cradle at all times.

Replacing The Battery Pack

When you notice the Wireless PTT Handset sounding a small chirp every couple of minutes, it indicates the battery is nearly flat and should be re-charged. The Wireless Handset will self power down after 30 minutes when voltage drops to that level. When you notice this occurring far more often than usual, it may mean it is time for the battery to be replaced.

Like all re-chargeable products, periodic replacement of the internal battery is required. The Wireless PTT Handset features a high capacity Lithium Ion battery. To maximize the life of a Lithium battery it is better to keep it topped up by returning it to the cradle or desktop charger often rather than waiting for it to first go flat which was the opposite case with older nickel based batteries. Typically you can expect to get about 500 re-charge cycles before the battery will require replacement.

Replacement of the battery should be ONLY undertaken by a qualified service technician so as to prevent damage to internal circuitry and to keep the housing's weatherproof integrity uncompromised.

After battery replacement, the Wireless PTT Handset must be first placed back into the charging cradle and should be

charged for 8-10 hours prior to next use. Depending on the situation it may also need to be "re-connected" to the desktop charger.

Pairing

Each Wireless PTT Handset is uniquely connected to a specific charging cradle in the factory. This ensures that all communications between the two units are secure and cannot be compromised or interfered with by a third party. A wireless handset is paired with its cradle while in production. When a wireless handset is docked to a different cradle, it does not automatically pair with a different cradle as it maintains its pairing configuration with the original cradle it came with.

To pair a wireless handset with a new cradle, press and hold the PTT button while pressing both blue volume controls for 8 seconds until the Wireless Handset speaker sounds a fast beeping tone alert. Now place the Wireless Handset back into the charging cradle. After a few seconds the Wireless Handset will sound a two tone confirmation and the red LED on both units will glow solid to indicate connection is complete.

Antennas

As compared to the basic internal stick antenna, the magnetic mount antenna provides enhanced coverage when placed on an unobstructed area of a vehicle's roof. It should be connected via its low loss coax cable to the RP-SMA-F output on the charging cradle. Make sure the cable is tight and secure.



WARNING

*Keep your body at least 20cm (8") away from vehicle mounted external antenna. See page 7 for other important details.
In the event of a damaged or lost antenna, only original replacements should be used so as to not compromise the unit's type approval certification or performance.*



IMPORTANT

The Wireless PTT Handset performs best when worn with the antenna extending up above your shoulder. This helps reduce the effects of body shielding and enhances overall coverage.

Coverage is always dependent on the local terrain, obstacles and the overall communications environment. For wider coverage, an external antenna should always be fitted to the roof of the vehicle. For best performance we recommend you use the supplied multipolarity antennas.

A variety of specialist vehicle antenna configurations are available to enhance into-building penetration or, to simply extend the overall communication zone around your vehicle. Ask your dealer which antenna configuration best suits your specific application.



INTERFERENCE:

Units operate in the 2.4GHz unlicensed band and may be subject to external interferences from other radio frequency transmitting devices.

Type Acceptance

Radio and Television Interference

The equipment described in this manual generates, uses, and radiates radiofrequency energy. If it is not installed and used correctly—it may cause interference with radio and television reception.

CE Declaration

This equipment has been tested and found to comply with the following harmonised European Norms:

- EN300328 (radio and telecommunications terminal equipment)
- EN55024 (electromagnetic immunity)
- EN55022 Class B (electromagnetic emissions)
- EN 60950 (electrical safety)
- EN301489 (electromagnetic compatibility and radio spectrum matters)

Based on the results of these tests, the supplier declares that the above mentioned devices conform to Article 10.1 of the European Council Directive 89/336/EEC, and their amendment Directive 93/68/EEC, and to the Directive 1999/5/EC and indicates this conformity by the CE-sign on each Wireless Handset. The Wireless Handset must be installed and operated in strict accordance with the instructions given in this user manual. Any changes or modifications to this product that were not specifically authorised will invalidate this declaration.

FCC Notice

This equipment complies with Part 15 of the FCC Rules.

Operation is subject to the following two conditions: (1) this Wireless Handset may not cause harmful interference, and (2) this Wireless Handset must accept any interference received, including interference that may cause undesired operation.

This equipment has been tested and found to comply with the limits for a Class B digital device, pursuant to Part 15 of FCC Rules. These limits are designed to provide reasonable protection against harmful interference in a residential installation. This equipment generates uses and can radiate radio frequency energy and, if not installed and used in accordance with the instructions, may cause harmful interference to radio communications. However, there is no guarantee that interference will not occur in a particular installation.

You can determine whether the equipment is causing interference by disconnecting power. If the interference stops, it was probably caused by the equipment. If the equipment does cause interference to radio or television reception, you may be able to correct the interference by using one or more of the following measures:

- Rotate the television or radio's antenna until the interference stops.
- Move the Wireless Handset farther away from the television or radio.

If necessary, consult your two way radio dealer or an experienced radio/ television technician for help. Changes or modifications to this product not authorized by Beam

Communications Pty Ltd could void the FCC Certification and negate your authority to operate the product.

Notice: Changes or modifications not expressly approved by the party for compliance could void the user's authority to operate the equipment.



IMPORTANT

To comply with the FCC RF exposure compliance requirements, no change to the antenna or the Wireless Handset is permitted. Any change to the antenna or the Wireless Handset could result in the Wireless Handset exceeding the RF exposure requirements and void user's authority to operate the Wireless Handset.

Industry Canada:

This Wireless Handset complies with Industry Canada licence-exempt RSS standard(s). Operation is subject to the following two conditions: (1) this Wireless Handset may not cause interference, and (2) this Wireless Handset must accept any interference, including interference that may cause undesired operation of the Wireless Handset.

Le présent appareil est conforme aux CNR d'Industrie Canada applicables aux appareils radio exempts de licence. L'exploitation est autorisée aux deux conditions suivantes : (1) l'appareil ne doit pas produire de brouillage, et (2) l'utilisateur de l'appareil doit accepter tout brouillage

radioélectrique subi, même si le brouillage est susceptible d'en compromettre le fonctionnement.

Important Safety and Handling Information

To avoid injury, read all operating instructions and the following safety information before using Wireless PTT Handset. For downloadable versions of the latest Wireless PTT Handset Kit User Guide, visit: www.beamcommunications.com/support



WARNING:

Failure to follow these safety instructions could result in fire, electric shock, or other injury or damage to PTT system or other property. Read all safety instructions for any products and accessories before using with Wireless Handset. Beam Communications is not responsible for the operation of, or any damage caused by, third-party accessories or their compliance with safety and regulatory standards.



INTERFERENCE:

Radio Frequency Interference:

Radio frequency emissions from electronic equipment can negatively affect the operation of other electronic equipment, causing them to malfunction. Although Wireless PTT Handset is designed, tested and manufactured to comply with regulations

governing radio frequency emission in countries such as the United States, Canada, the European Union, and Japan, the wireless transmitters and electrical circuits in the PTT system may cause interference in other electronic equipment. Therefore, please take the following precautions:

- I. Aircraft: Use of Wireless Handset may be prohibited while travelling in aircraft.*
- II. Vehicles: radio frequency emissions from Wireless Handset may affect electronic systems in motor vehicles. Check with the manufacturer or its representative regarding your vehicle.*
- III. Pacemakers: The Health Industry Manufacturers Association recommends that a minimum separation of 15 cm (6 inches) be maintained between a handheld Wireless Handset and a pacemaker to avoid potential interference with the pacemaker. Persons with pacemakers:*
 - Should always keep Wireless Handset more than 15 cm (6 inches) from the pacemaker when turned on.*
 - Should not carry Wireless Handset in a breast pocket.*
 - Should use the ear opposite the pacemaker to minimize the potential for interference. If you have any reason to suspect that interference is taking place, turn the Wireless Handset off immediately.*
 - The Wireless handset may interfere with some hearing aids. If you experience interference, consult the hearing aid manufacturer or your physician for alternatives or remedies.*
- IV. Other Medical Devices: If you use any other personal medical device, consult the device manufacturer or your*

physician to determine if it is adequately shielded from radio frequency emissions from Wireless Handset.

- V. Health Care Facilities: Hospitals and health care facilities may use equipment that is particularly sensitive to external radio frequency emissions. Turn the Wireless Handset off when staff or posted signs instruct you to do so.*
- VI. Blasting Areas and Posted Facilities: To avoid interfering with blasting operations, turn off the Wireless Handset when in a "blasting area" or in areas posted "Turn off two-way radio." Obey all signs and instructions.*

Exposure to Radio Frequency Energy:

*The Wireless Handset transmits and receives radio frequency (RF) energy through its antennas. The antennas are located at the top edge of the Wireless Handset. The handset is designed and manufactured to comply with the limits for exposure to RF energy set by international regulatory agencies, including the FCC of the United States, IC of Canada, MIC of Japan, and the Counsel of the European Union, among others. The Wireless Handset has been tested and meets the FCC, IC, and European Union RF exposure guidelines for 802.15 operation. To ensure exposure levels remain at or below the maximum safe levels, when carrying the unit **ONLY** use the Wireless Handset with the manufacturer's supplied clothing clip or a non-metallic holder that ensures the antenna remains greater than 25mm (1 inch) from your body at all times. An external antenna is connected to the output connector on the charging cradle or to the output connector on the XBDA bidirectional amplifier. Always keep your body at least 20cm (8") from the vehicle mounted external antenna. The XBDA is only approved for use with the Wireless Handset unit when in*

accordance with individual country type approval regulations.

Battery Replacement:

Do not attempt to replace the rechargeable battery in Wireless PTT Handset yourself. The battery should be replaced only by an Authorized Service Provider. The battery should be recycled/disposed of thoughtfully.

Antenna Replacement:

Only use the antennas supplied. Use of other antenna types will void type approval.

This radio transmitter (IC:11443A-X10DRMD) was approved by Industry Canada to operate with the antenna types listed below the maximum permissible gain and required antenna impedance for each antenna type indicated. Types of antennas not included in this manual, having a higher gain than the maximum gain indicated this type are strictly prohibited for use with this device.

Cet émetteur radio (identifier le dispositif par numéro de certification ou le numéro de modèle de la catégorie II) a été approuvé par Industrie Canada pour fonctionner avec les types d'antenne énumérés ci-après le gain maximal autorisé et de l'impédance d'antenne requise pour chaque type d'antenne indiqué. Types d'antennes ne sont pas inclus dans cette liste, ayant un gain supérieur au gain maximum indiqué ce type sont strictement interdits pour une utilisation avec cet appareil.

Informations importantes de sécurité et de manutention

Pour éviter toute blessure, lisez toutes les instructions et les consignes de sécurité suivantes avant d'utiliser le combiné sans fil. Pour les versions téléchargeables de la dernière version du Guide de l'utilisateur du combiné sans fil, visitez: www.wirelesscorp ltd.com



AVERTISSEMENT

Le non-respect de ces consignes de sécurité peut provoquer un incendie, de choc électrique ou d'autres blessures ou des dommages au combiné sans fil ou à d'autres biens. Lisez toutes les instructions de sécurité pour tous les produits et accessoires avant d'utiliser le combiné sans fil. CMT n'est pas responsable de l'exploitation, ou tout dommage causé par des accessoires tiers ou de leur conformité aux normes de sécurité et réglementaires.



Interférence radio

L'émission de fréquences radio émises par les équipements électroniques peut affecter négativement le fonctionnement des autres appareils électroniques, les rendant dysfonctionnels. Bien que le combiné sans fil soit conçu, testé et fabriqué conformément aux règlements régissant l'émission de radiofréquences dans les pays comme les États-Unis, le Canada, l'Union Européenne et le Japon, les émetteurs sans fil et les circuits électriques dans le combiné sans fil peuvent provoquer des interférences avec d'autres équipements électroniques. Par

conséquent, prenez les précautions suivantes:

i/ Avion: L'utilisation du combiné sans fil peut être interdite dans les avions.

ii/ Véhicules: les émissions de radiofréquences par le combiné sans fil peuvent affecter les systèmes électroniques des véhicules à moteur. Vérifiez auprès du fabricant de votre véhicule ou de son représentant.

Atmosphères explosives:

Désactiver le combiné sans fil dans des zones avec une atmosphère potentiellement explosive. Ne chargez pas le combiné sans fil, et respectez tous les panneaux et instructions. Des étincelles dans de telles zones pourraient causer une explosion ou un incendie, causant des blessures graves ou même la mort.

Les zones à atmosphère potentiellement explosive sont souvent, mais pas toujours, clairement indiquées. Les zones potentielles comprennent: les zones de carburant (comme les stations d'essence), sous le pont des bateaux, endroits de transfert ou de stockage de produits chimiques et carburants, les véhicules utilisant du gaz de pétrole liquéfié (comme le propane ou le butane), des zones où l'air contient des produits chimiques ou des particules (le grain, la poussière ou les poudres métalliques) et tout autre endroit où il vous serait normalement recommandé d'arrêter le moteur de votre véhicule.

Charging your Wireless PTT Handset:

To charge the Wireless PTT Handset, use only the charging cradle or desktop charger supplied.

If you use the desktop charger to charge the handset, make sure that the power adapter is fully assembled before you plug it into a power outlet. Then insert the AC/DC plug pack firmly into the power outlet. Do not connect or disconnect the AC/DC plug pack with wet hands. The AC/DC plug pack may become warm during normal use. Always allow adequate ventilation around the AC/DC plug pack and use care when handling. Unplug the AC/DC plug pack if any of the following conditions exist:

1. The power cord or plug has become frayed or damaged.
2. The adapter is exposed to rain, liquid, or excessive moisture.
3. The adapter case has become damaged.
4. You suspect the adapter needs service or repair.
5. You want to clean the adapter.

Cleaning your Wireless PTT Handset:

Clean the Wireless PTT Handset immediately if it comes into contact with any contaminants that may cause possible malfunctions—for example, ink, dyes, makeup, dirt, food, oils, and lotions. To clean the handset, unplug all cables and turn off the handset (press and hold the manual On/Off button). Then use a soft, slightly damp cloth. Don't use abrasive household or industrial cleaners, aerosol sprays, solvents, alcohol, ammonia to clean the Wireless Handset.

Carrying and handling Wireless PTT Handset:

The Wireless PTT Handset contains sensitive components. Do not drop, disassemble, microwave, burn, paint, or insert foreign objects into handset. Do not use the Wireless Handset if it has

been damaged—for example, if the Wireless Handset is cracked, punctured, or damaged by water.

Connectors and Press Buttons:

Never force a connector into a port or apply excessive pressure to a button, because this may cause damage that is not covered under the warranty. If the connector and port don't join with reasonable ease, they probably don't match. Check for obstructions and make sure that the connector matches the port and that you have positioned the connector correctly in relation to the port. Not all Hirose 6 pin accessories are fully compatible with Wireless PTT Handsets. Under some conditions, certain accessories may affect Wireless PTT Handset performance. Reorienting or relocating the handset and the connected accessory may improve wireless performance. Connect your BEAM Reseller for advice.

Acceptable Temperature Extremes:

The Wireless PTT Handset is designed to be normally operated and stored in temperatures between -20°C and 50°C (-4° to 122°F). Lower or higher temperature conditions might shorten battery life or cause the handset to temporarily stop working correctly. Leaving Wireless Handset in a parked vehicle or in direct sunlight can cause handset to exceed these storage or operating temperature ranges. Avoid rapid changes in temperature or humidity when using the handset, as condensation may form within the unit. When you're using the Wireless Handset or charging the battery, it is normal for Wireless Handset to get warm. The battery will only charge when its ambient temperature is within its safe limits of 0°C - 45°C.

Specifications

PTT Corded Handset

Dimensions	mm	inches
Corded Handset	88L x 63W x 28D	3.46L x 2.48W x 1.1D
Cable Cord (relaxed length)		
Weight	kg	lbs
Weight	0.149	0.328

PTT Wireless Handset

Dimensions	mm	inches
Wireless Handset	88 x 28 x 63	3.46 x 1.1 x 2.48
Charging Cradle	80 x 80 x 60	3.15 x 3.15 x 2.36
Weight	kg	lbs
Handset	0.149	0.328
Charging Cradle	0.125	0.275
Operating Temperature	-20°C to +50°C	-4°F to +122°F
Frequency	2.40-2.48GHz FH Spread Spectrum	
Protocol	802.15.4 based derivative	
RF Power	<100mW	
Battery Type	3.7V @ 1200mA Lithium Ion	
Battery Life	>12 Hours @ 30% receive time	
Encryption	SAFER+ 64Bit std/ 128Bit Advanced model	
RF Connectors	RP SMA Female	
Audio/Distortion	>250mW @5% THD	
Hirose Audio Port	Industry standard - Hirose HR10-7R-65 accessory port	
Audio Port	Standard 3.5mm mono jack (TS)	
Power Input Voltage	6-16VDC (supplied by Extreme Dock)	
Vibration and Shock	Mil Std 810 C/D/E/F	
Humidity/Rain/Dust	IEC529, IP55 (Wireless Handset only)	
Type Acceptance	Aust/NZ, FCC, CE Compliance, Industry Canada	

PTT Privacy Handset

Dimensions	mm	inches
Handset	190L x 49.7W x 27.13H	7.48L x 1.95W x 1.06H
Mounting Cup	64W x 95L	2.51W x 3.74H
Cable Cord Dimensions (relaxed length)	595	23.43
Weight	kg	lbs
Privacy Handset	0.25	0.55

Grab 'n' Go Cases

Dimensions	mm	inches
PTT Grab 'N' Go - Large case	401L x 307W x 173H	15.8L x 12.1W x 6.8H
PTT Grab 'N' Go - Small case	318L x 257W x 152H	12.5L x 10.1W x 6.0H

Beam Warranty Terms & Conditions

Beam Communications gives this express warranty (along with extended warranty endorsements, where applicable) in lieu of all other warranties, express or implied, including (without limitation), warranties of merchantability and fitness for a particular purpose. This constitutes our sole warranty and obligation with regard to our products as well as the Customer's sole remedy.

Beam Communications expressly disclaims all liability and responsibility for any special, indirect or consequential damages or any further loss of any kind whatsoever resulting from the use of our product(s). The Customer's sole and exclusive remedy and the limit of Beam's liability for any loss whatsoever, shall not exceed the purchase price paid by the Customer for the product to which a claim is made.

All products manufactured by Beam Communications are warranted to be free from defects in material and workmanship in accordance with and subject to the following terms and conditions:

1. This warranty is limited to the original Customer only. It cannot be transferred or assigned to third parties unless the intent to transfer to a third party is expressly indicated in a purchase order and/or warranty-processing arrangements have been agreed upon in writing by Beam.
2. Beam Communications does not warrant any installation, maintenance or service of the Products not performed by Beam, nor does it warrant the use of Products with unapproved ancillary products.
3. Beam Communications will correct any defects in material or workmanship of products manufactured by Beam which appear within twelve (12) months, from the date of shipment by Beam Communications to the Customer. Exception to a 12 months warranty are:
 - Units that they do not carry a transceiver (24 months warranty)
 - Accessories (3 months warranty)Please note that antennas and products not manufactured by Beam (like; NAL Shout Nano, Man down Kit, RST970, 9522B and 9602) also come with a 12 month warranty. Beam Communications will repair or replace, at our option, any defective product, provided that our analysis and/or inspection disclose that such defects developed under normal and proper use.
4. This warranty does not extend to goods subjected to liquid or particulate ingress, extreme humidity, misuse, neglect, accident or improper installation, or to maintenance or repair of products that have been altered or repaired by anyone except Beam Communications unless otherwise stated in writing. If a product has been tampered with (e.g. warranty seal has been removed, wrong cable has been used with an antenna), the warranty will be void.
5. The warranty is a return-to-base warranty and freight is paid by the sender.

6. A charge of USD\$195.00 including return freight will be made for testing returned product which is not defective or is found to be defective as the result of improper use, maintenance or neglect.
7. Beam Communications will not accept responsibility for any invoiced goods or services that are not covered by a Beam Communications written purchase order. Under no circumstances does Beam Communications agree to pay for labor or other related expenses associated with the troubleshooting and/or repair of our product without prior specific written authorization.
8. Information in our descriptive literature is based on product specifications that are current at the time of publication. Product specifications, designs and descriptive literature are subject to change as improvements are introduced. Although we announce changes as they occur, we cannot guarantee notification to every Customer. Beam Communications warrants delivered product to conform to the most current specifications, designs and descriptive literature.
9. This warranty policy may be expanded or limited, for particular categories of products or Customers, by information sheets published as deemed appropriate by Beam Communications. In particular, the warranty for third party Products is that of the third party and not Beams warranty.



Legal: The Bluetooth® word, mark and logos are owned by Bluetooth SIG, Inc. Other trademarks and trade names are those of their respective owners.



Remote Satellite Systems
INTERNATIONAL

TOLL FREE 1-888-989-8199

1455 N. Dutton Suite A, Santa Rosa, CA 95401
FAX 707-546-8198 • info@remotesatellite.com
www.remotesatellite.com